

normann

C O P E N H A G E N

Norm 69

SAMLEINSTRUKTION

MONTERINGSANVISNINGAR

MONTERINGSINSTRUKER

ASSEMBLY INSTRUCTIONS

MONTAGEANLEITUNG

INSTRUCTIONS D'ASSEMBLAGE

INSTRUCCIONES DE MONTAJE

ISTRUZIONI DI MONTAGGIO

MONTAGE-INSTRUCTIE

规格69组装指南/中文

規格69組み立て指示書/日本語

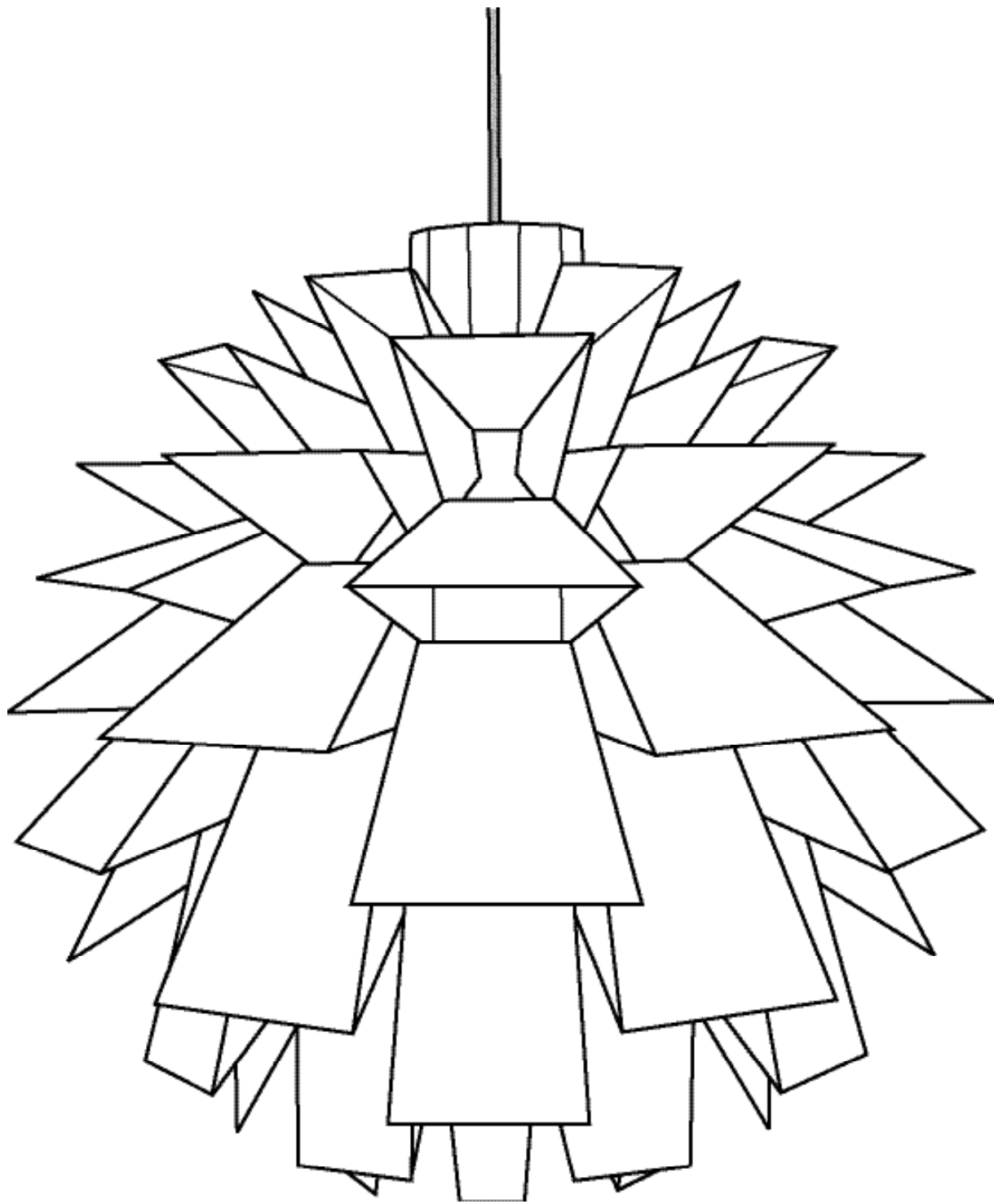

Norm 69

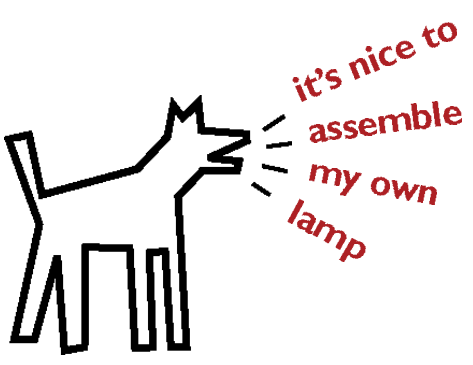

*it's nice to
assemble
my own
lamp*

Samlelampe i 69 dele, samles uden værktøj eller lim, maksimal udnyttelse af lyseffekt, total blændfri.

Obs! Det er helt afgørende, at elementerne samles i den rigtige rækkefølge. Tag derfor kun ét sæt elementer ud af pakken ad gangen.

Alle elementer skal samles med den matte side udad.

1.

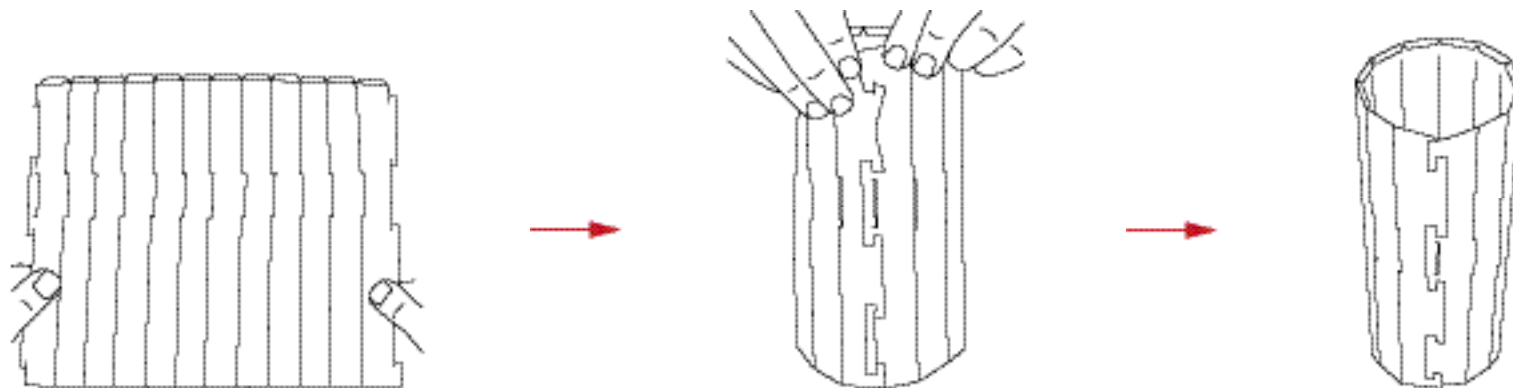

Sokkel 'knipses' sammen til en 12-kantet cylinder.
Ombukkede kant opad.

2.

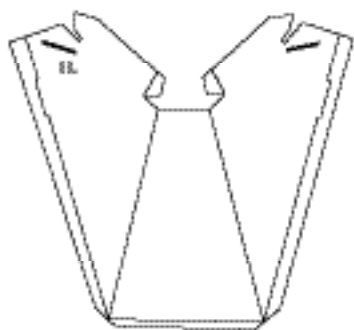

6 stk. elementer mrk. '11' tages ud af pakken.
Overflødigt materiale i de to slidser prikkes ud.

3.

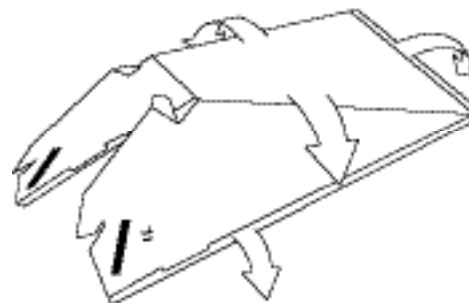

Elementerne foldes, som vist.
Forstærkningskanter bukkes helt om.

4.

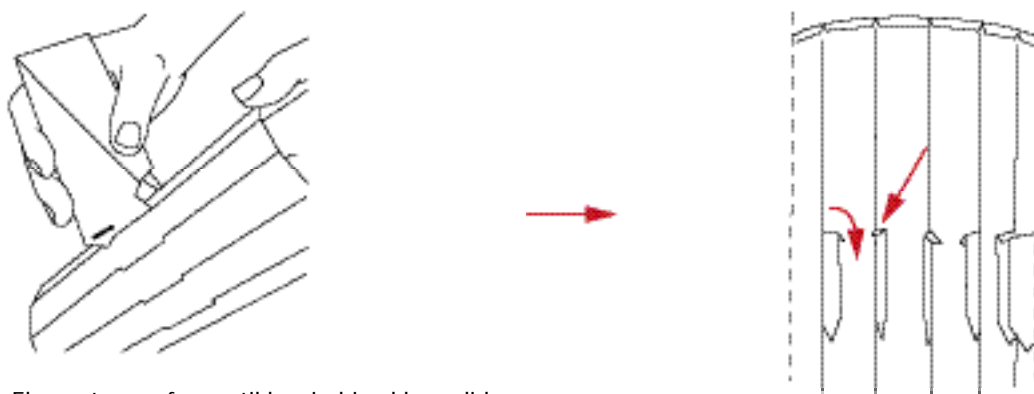

Elementernes faner stikkes ind i soklens slidser –
og snipper rettes ud på indersiden.

SAMLEINSTRUKTION NORM 69/DANSK

5.

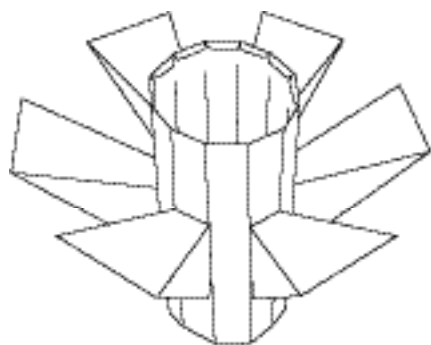

Sokkel med påhæftede '11'-elementer.
Vendes på hovedet.
6 stk.'10'-elementer foldes som '11'-elementerne.

6.

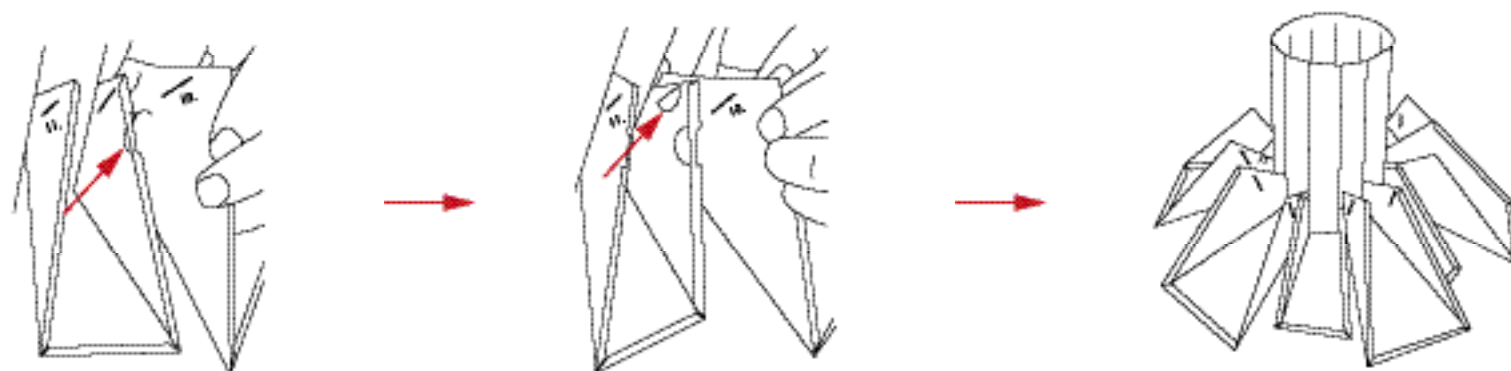

6 stk.'10'-elementer hægtes på
'11'-elementerne, som vist.

7.

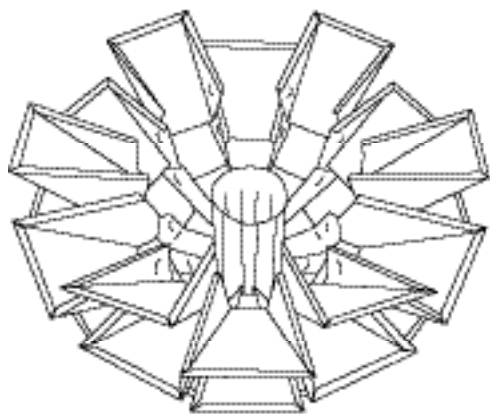

På samme måde foldes og påhægtes
6 stk.'9'-, '8'- og '7'-elementer.

8.

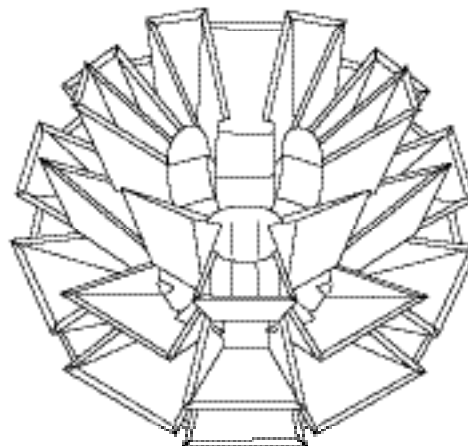

På samme måde foldes og påhægtes
6 stk.'6'-, '5'- og '4'-elementer.

9.

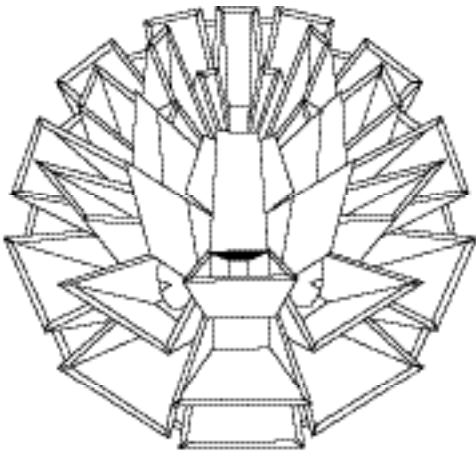

Fold og påhægt til sidst 6 stk. '3'-, '2' - og '1'-elementer.

10.

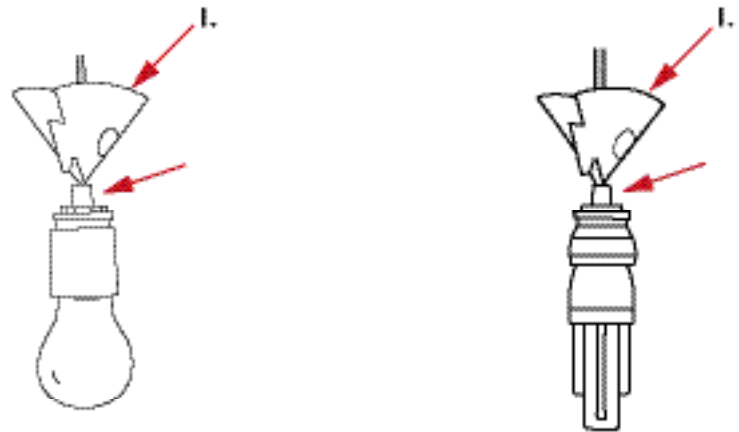

Det første ophængselement "knipses" sammen om ledningen – med spidsen nedad. **VIGTIGT!** Der skal være afstand mellem fatning og ophængselement. Derfor **SKAL** vedlagte nippel monteres på ledningen, som vist på tegningen.

11.

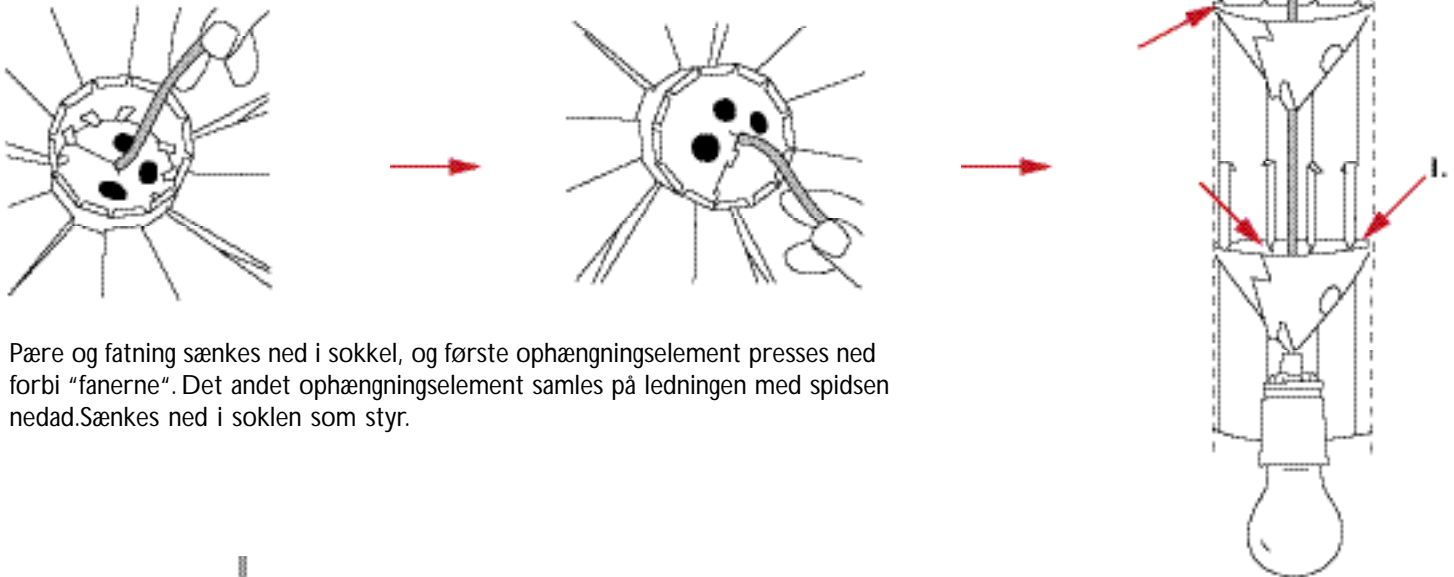

Pære og fatning sænkes ned i sokkel, og første ophængningselement presses ned forbi "fanerne". Det andet ophængningselement samles på ledningen med spidsen nedad. Sænkes ned i soklen som styr.

12.

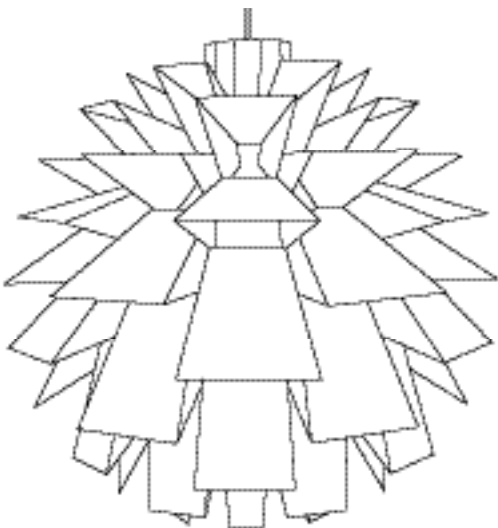

Færdig lampe klar til ophæng.

Ophængning af lampe.

Lampen kan hænges op uden at afmontere lampefatning. Udskiftning af pære kan nemt foretages gennem lampens fleksible bund.

MAKS. 60 WATT

MONTERINGSANVISNINGAR NORM 69/SVENSKA

Gör det själv-lampa i 69 delar, sätts ihop utan verktyg och lim,maximalt utnyttjande av ljuseffekten,helt bländfri.

Obs! Det är mycket viktigt att delarna sätts ihop i rätt ordningsföljd. Ta därför bara ut ett set delar i taget ur förpackningen.

Samtliga delar ska monteras med den matta sidan utåt.

1.

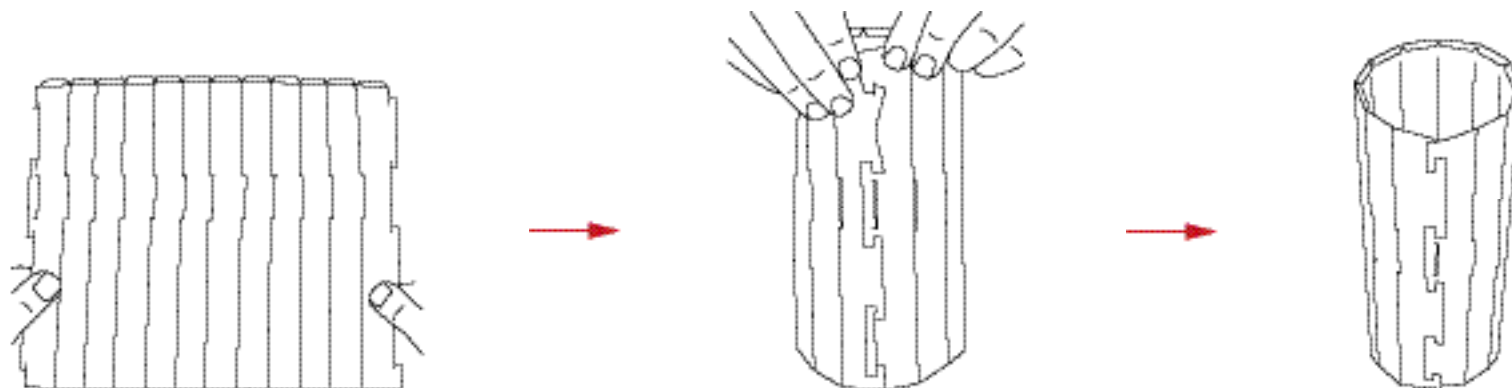

Sätt ihop sockeln till en tolvkantig cylinder.
Den bockade kanten ska vända uppåt.

2.

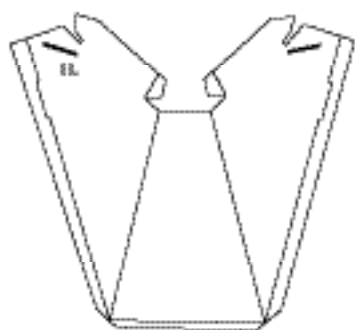

Ta ut 6 delar märkta med "11" ur förpackningen.
Tryck ut överskottsmaterialet i de två slitsarna.

3.

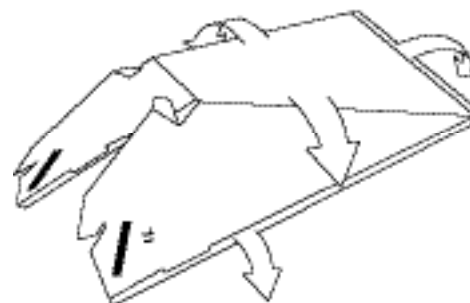

Vik delarna enligt ritningen.
Vik över förstärkningskanterna på den andra sidan.

4.

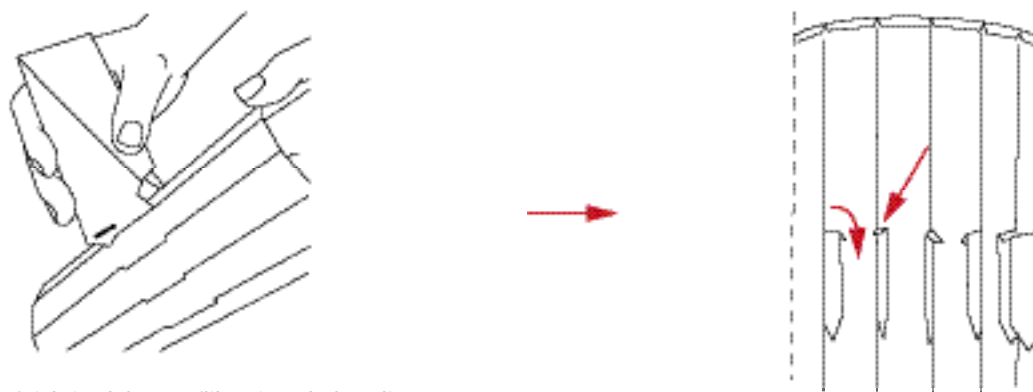

Stick in delarnas flikar i sockelns slitsar –
och räta ut snibbarna på insidan.

5.

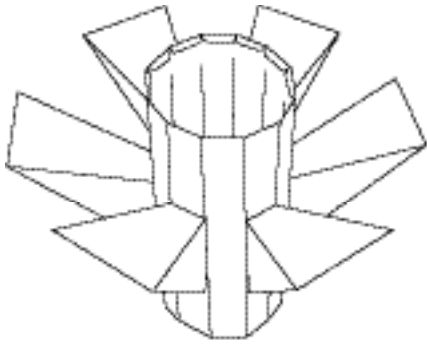

Sockel med fastsatta "11"-delar.
Vänd sockeln upp och ned.
Vik 6 delar märkta med "10" på samma sätt som "11"-delarna.

6.

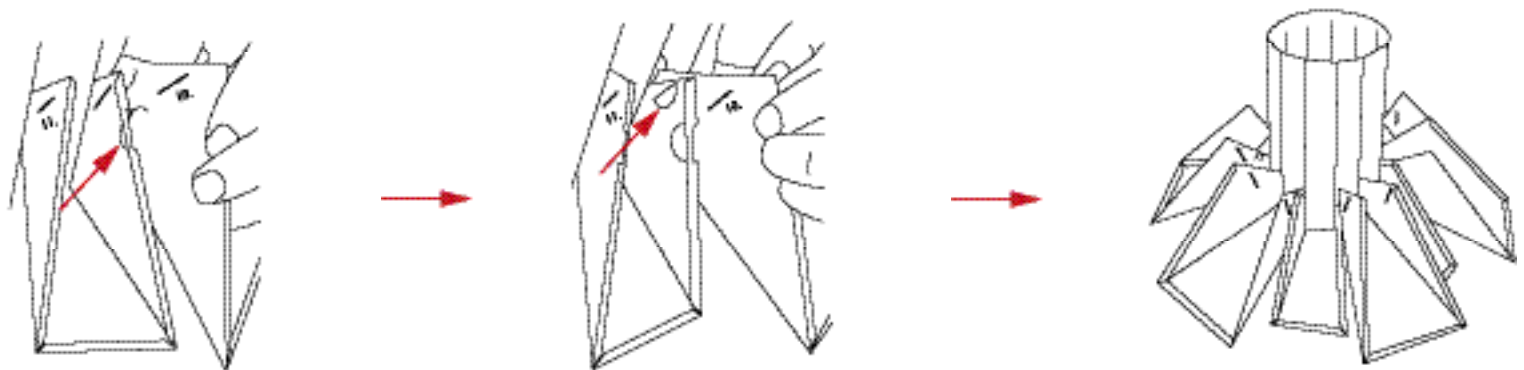

Haka fast de 6 delarna märkta med
"10" på "11"-delarna enligt ritningen.

7.

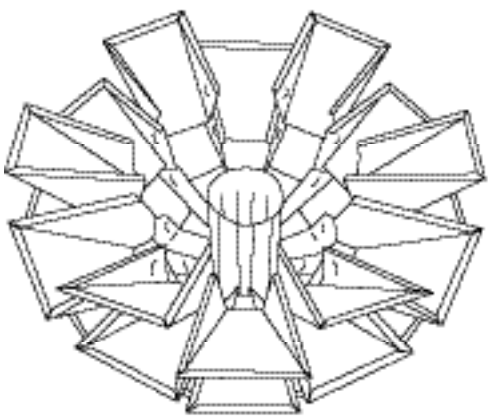

Vik och haka fast 6 delar märkta med
"9", "8" och "7" på samma sätt.

8.

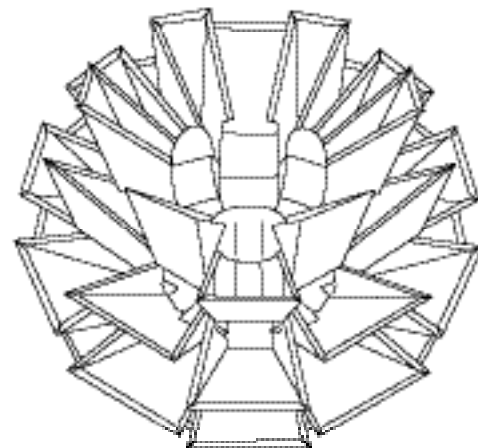

Vik och haka fast 6 delar märkta med
"6", "5" och "4" på samma sätt.

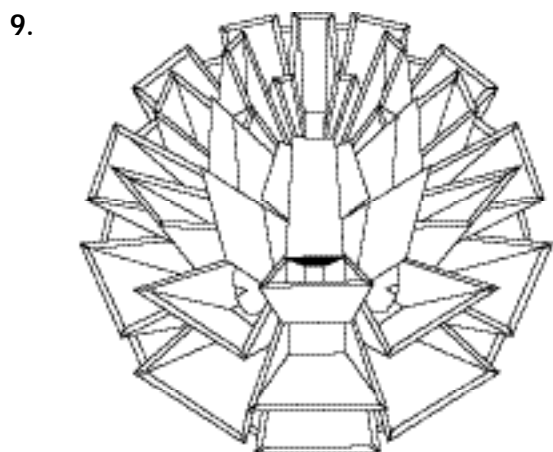

Vik och haka till sist fast 6 delar märkta med "3", "2" och "1" på samma sätt.

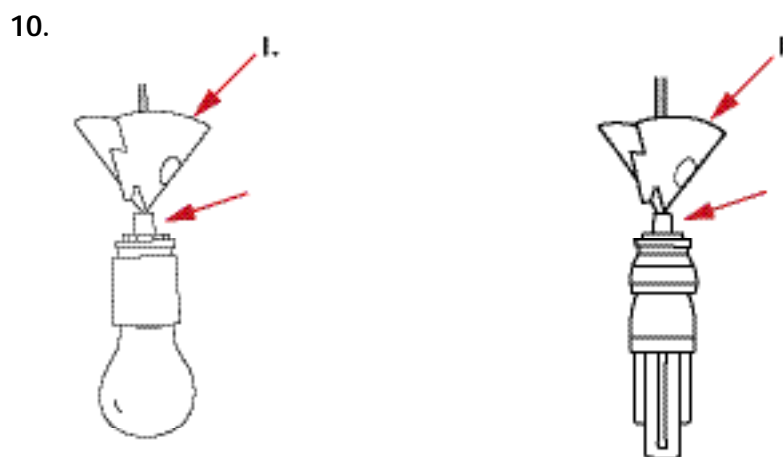

"Knip" fast den första upphängningsdelen runt sladden – med spetsen neråt. **VIKTIGT!** Det måste vara ett mellanrum mellan fattningen och upphängningsdelen. Därför **MÅSTE** den bifogade nippeln monteras på sladden enligt ritningen.

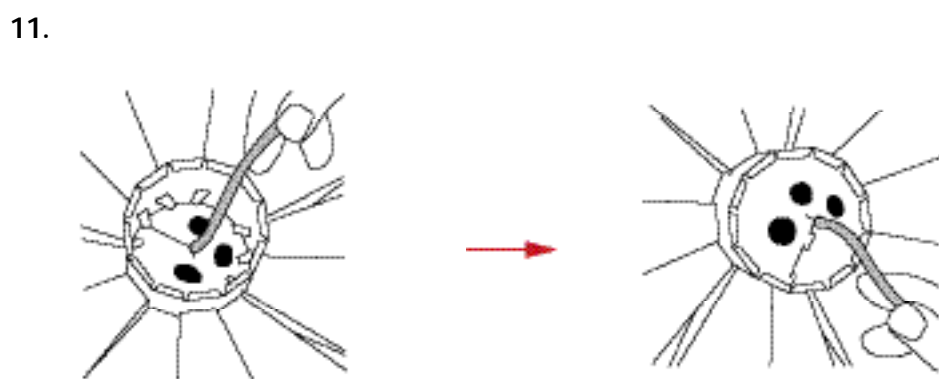

Sänk ner glödlampan och fattningen i sockeln och pressa ner den första upphängningsdelen förbi "flikarna". Sätt fast den andra upphängningsdelen på sladden med spetsen neråt. Sänk ner den i sockeln som styrdel.

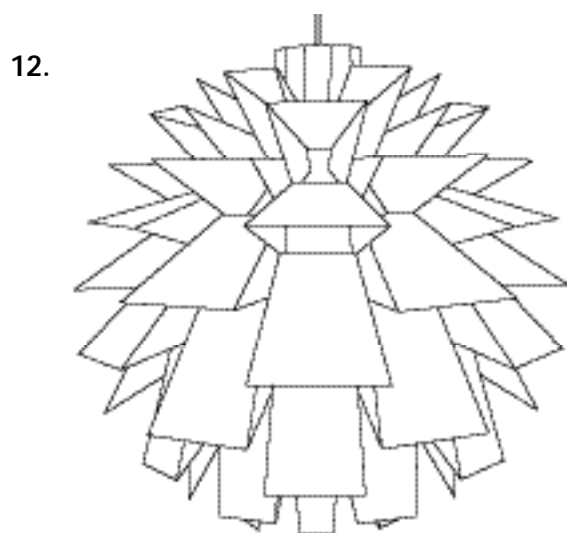
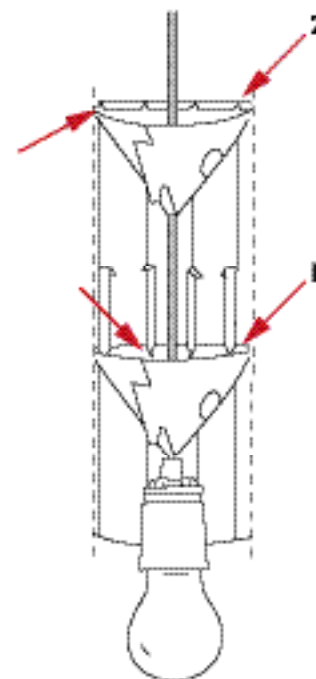

Lampan är klar att hänga upp.

Upphängning av lampa

Lampan kan hängas upp utan att fattningen behöver tas av. Glödlampan byter du lätt genom lampans flexibla botten.

MAX.60 WATT

Lampe som skal monteres i 69 deler. Settes sammen uten bruk av verktøy eller lim, gir maksimal utnyttelse av lyseffekt og er fullstendig blendingsfri. **Obs!** Det er meget viktig at de forskjellige delene settes sammen i riktig rekkefølge. Ta derfor kun ut ett delesett av pakken om gangen.

Alle delene settes sammen slik at den matte siden vender utover.

1.

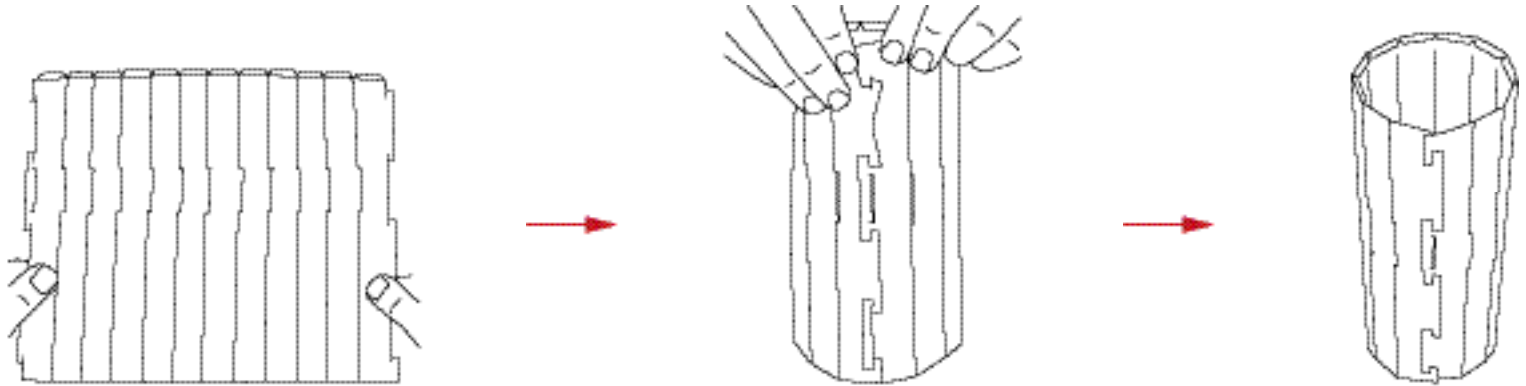

Sokkelen settes sammen til en 12-kantet sylinder.
Den brettede kanten skal vende oppover.

2.

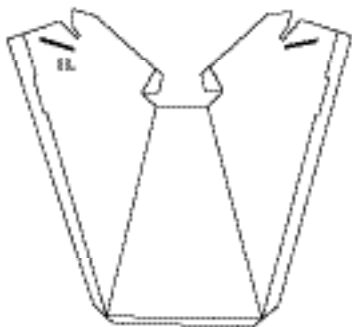

6 stk. deler merket med '11' tas ut av pakken.
Overflødig materiale i de to spaltene prikkes ut.

3.

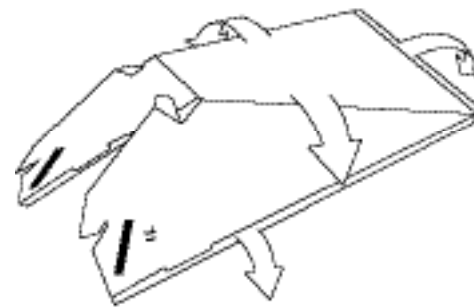

Delene brettes som vist.
Forsterkningskantene brettes fullstendig.

4.

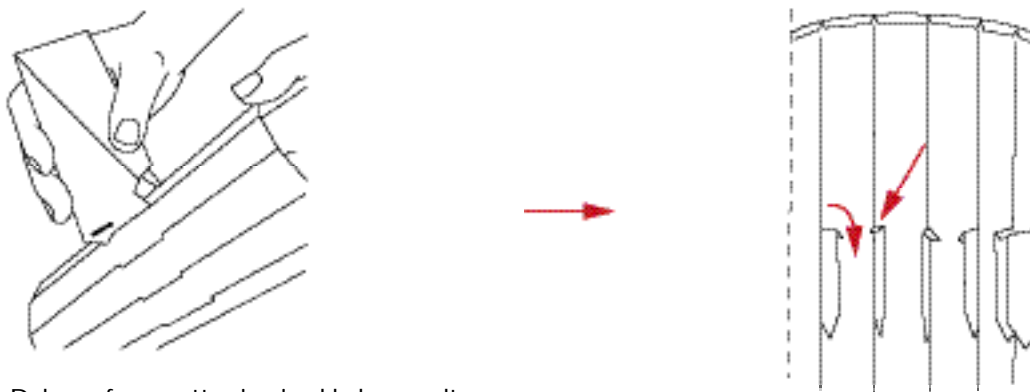

Delenes faner settes inn i sokkelens spalter –
og snippene rettes ut på innsiden.

5.

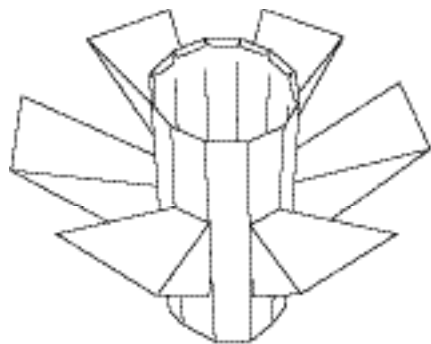

Sokkelen med de påheftede '11'-delene snus opp ned.
6 stk.'10'-deler brettes på samme måte som '11'-delene.

6.

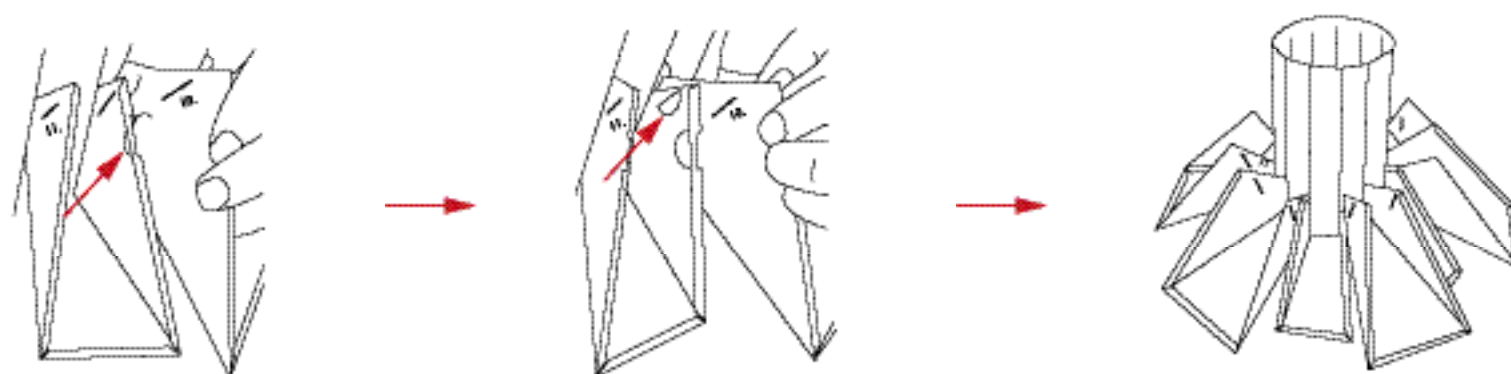

6 stk.'10'-deler hektes på
'11'-delene, som vist.

7.

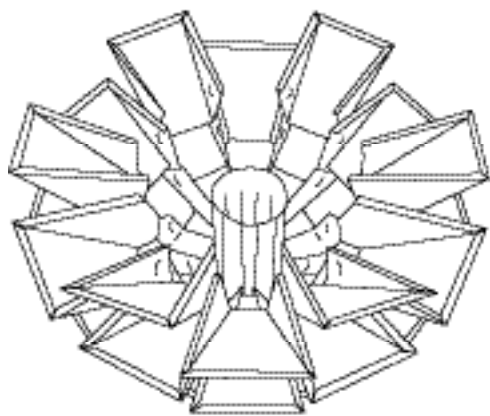

På samme måte brettes og hektes
6 stk.'9'-, '8'- og '7'-delene på.

8.

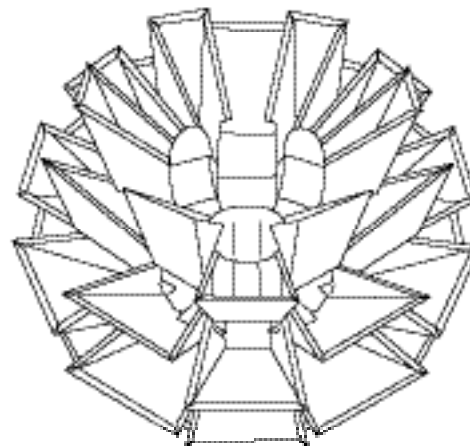

På samme måte brettes og hektes
6 stk.'6'-, '5'- og '4'-delene på.

9.

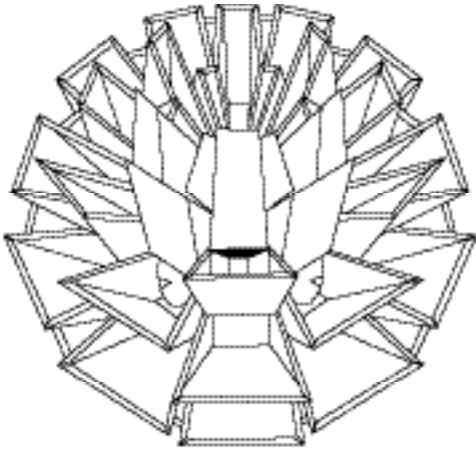

Til slutt brettes og hektes 6 stk. '3'-, '2'- og '1'-delene på.

10.

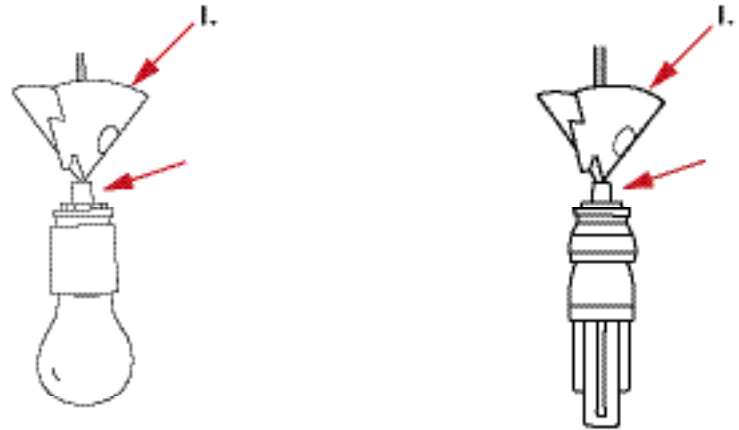

Den første opphengsdelen settes sammen rundt ledningen med spissen vendt nedover. **VIKTIG!** Det må være avstand mellom lampedelen og opphengsdelen. Derfor **MÅ** vedlagte kilehake monteres på ledningen som vist på tegningen.

11.

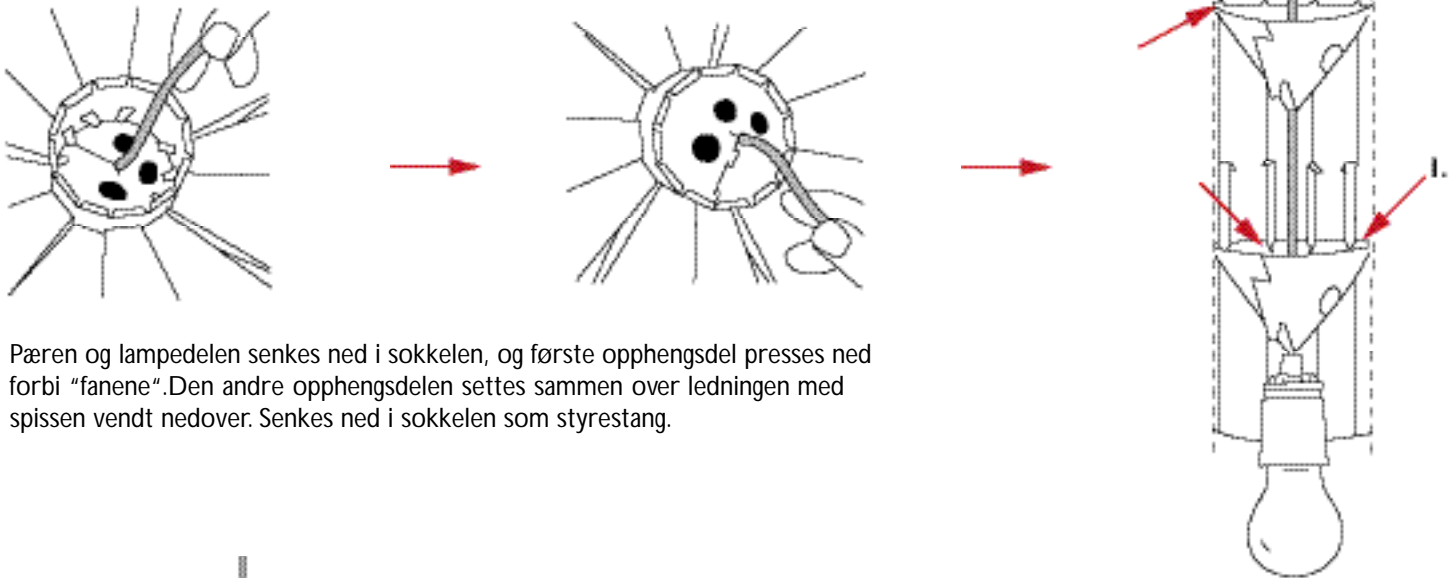

Pæren og lampedelen senkes ned i sokkelen, og første opphengsdelen presses ned forbi "fanene". Den andre opphengsdelen settes sammen over ledningen med spissen vendt nedover. Senkes ned i sokkelen som styrestang.

12.

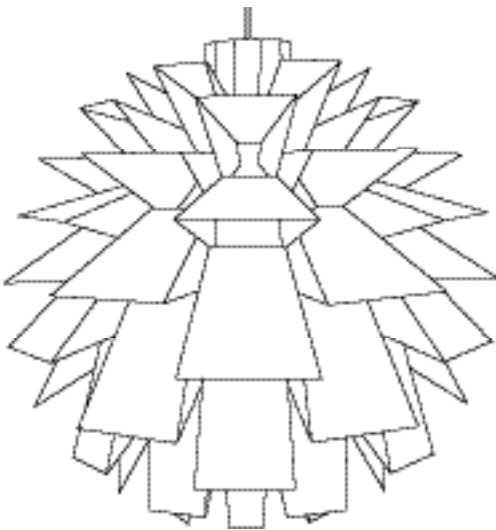

Ferdig lampe klar til å henges opp.

Opphenging av lampen.

Lampen kan henges opp uten at lampedelen må demonteres. Skifting av pære skjer enkelt gjennom lampens fleksible bunn.

MAKS.60 WATT

ASSEMBLY INSTRUCTIONS NORM 69/ENGLISH

Lamp kit with 69 parts. May be assembled without the use of tools or glue. Maximum light use efficiency. Totally glare-free. **Note!** It is very important that the elements are assembled in the correct sequence, so you should only take one set of elements out of the package at a time.

All elements should be assembled with the matt side outwards.

1.

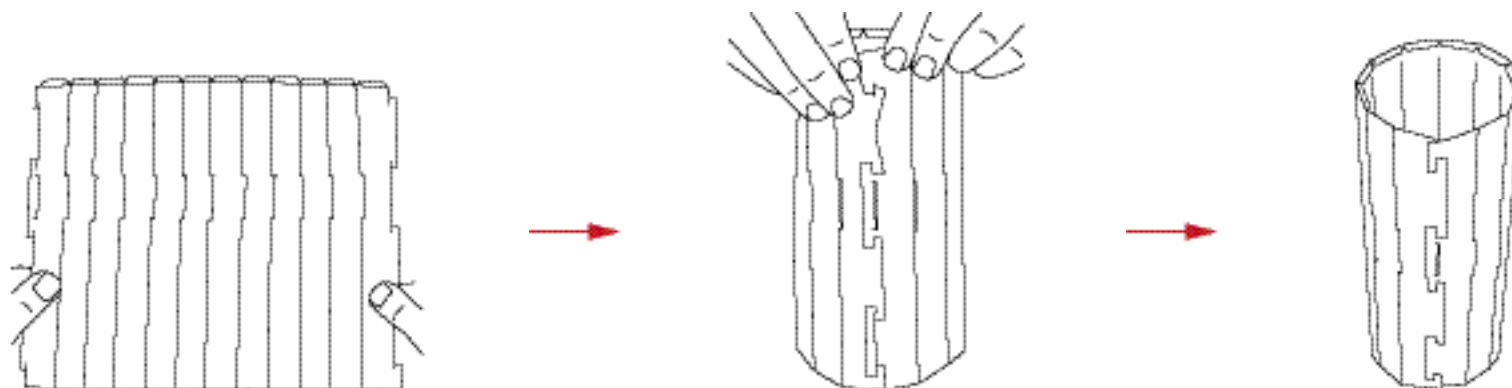

"Snap" the central element together to form a 12-sided cylinder.
The folded-up edge should be uppermost.

2.

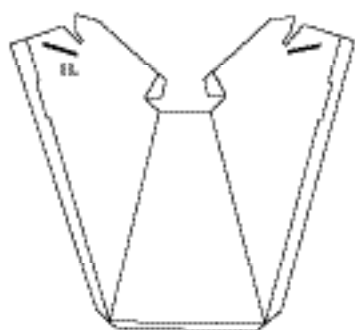

Take six of the elements marked '11' out of the package. Remove any superfluous material from the two slits.

3.

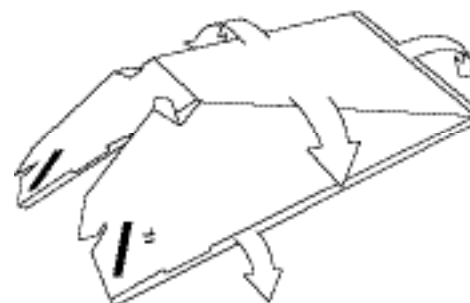

Fold the elements as shown.
Fold the reinforcing edges up all the way around.

4.

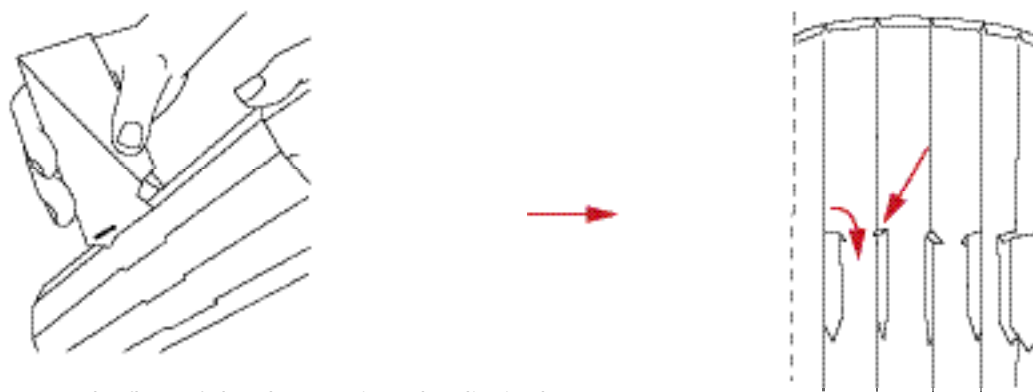

Insert the flaps of the elements into the slits in the central cylinder and cut off the ends on the inside.

5.

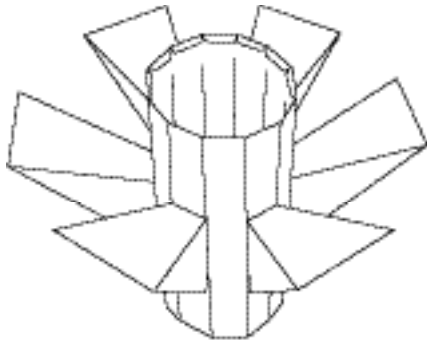

Cylinder with the '11' elements mounted.
Turn upside down.
Take six of the '10' elements and fold them
in the same way as the '11' elements.

6.

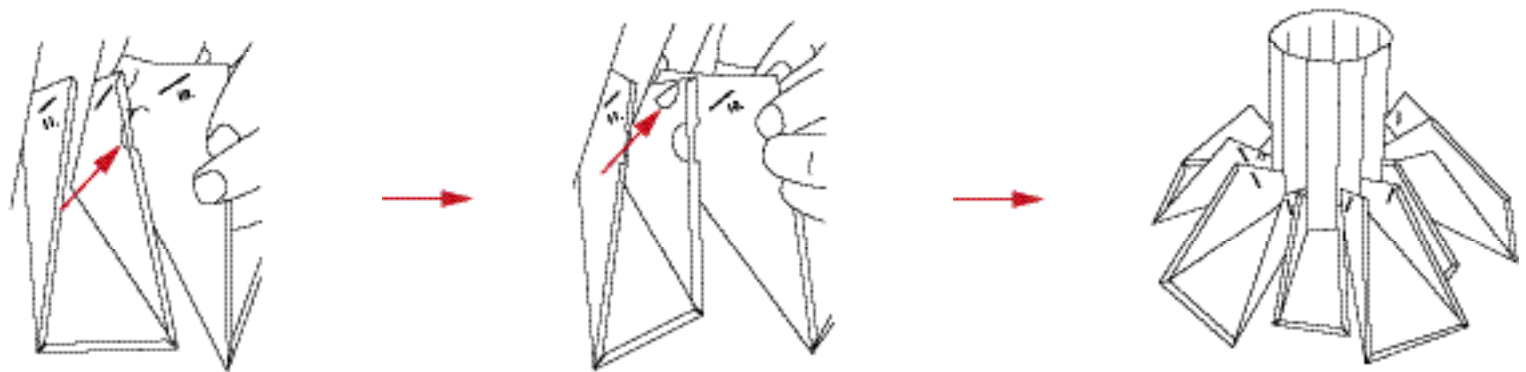

Attach the six '10' elements to
the '11' elements, as shown.

7.

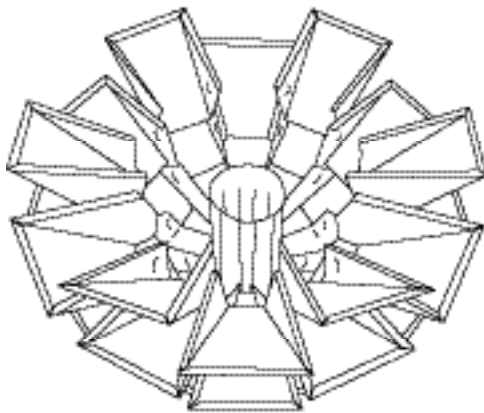

Fold and attach six of each of the '9',
'8' and '7' elements in the same way.

8.

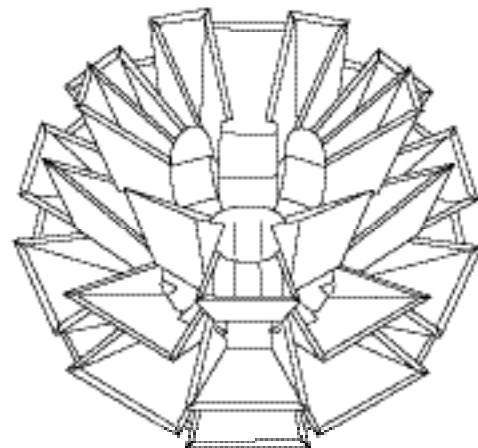

Fold and attach six of each of the '6',
'5' and '4' elements in the same way.

9.

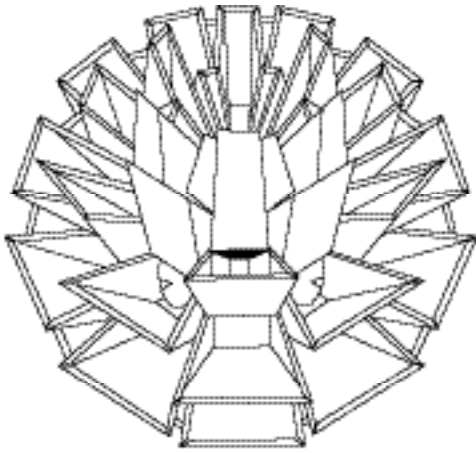

Finally, fold and attach six of the '3','2' and '1' elements.

10.

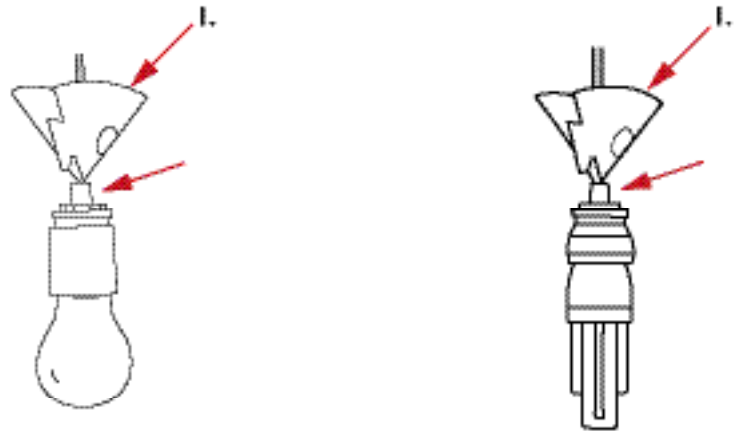

"Snap" the first hanging element around the cable with the point downwards. **IMPORTANT!** There must be a gap between the bulb socket and the hanging element, so the accompanying spacer **MUST** be fitted to the cable as shown in the drawing.

11.

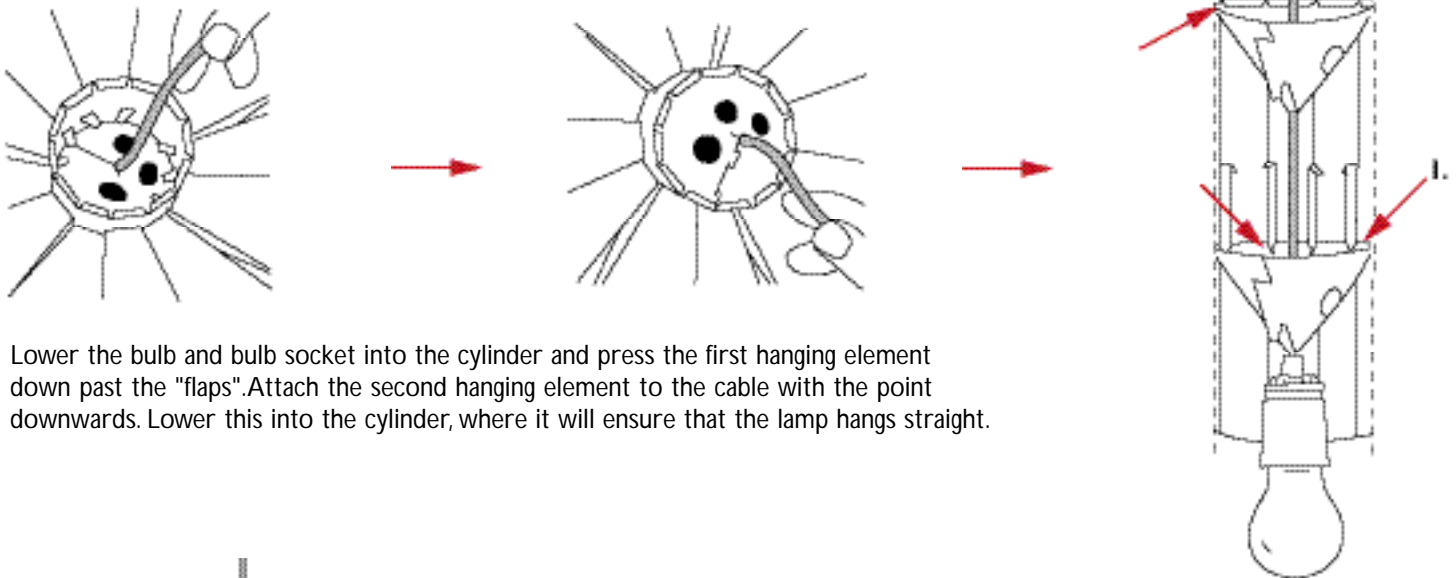

Lower the bulb and bulb socket into the cylinder and press the first hanging element down past the "flaps". Attach the second hanging element to the cable with the point downwards. Lower this into the cylinder, where it will ensure that the lamp hangs straight.

12.

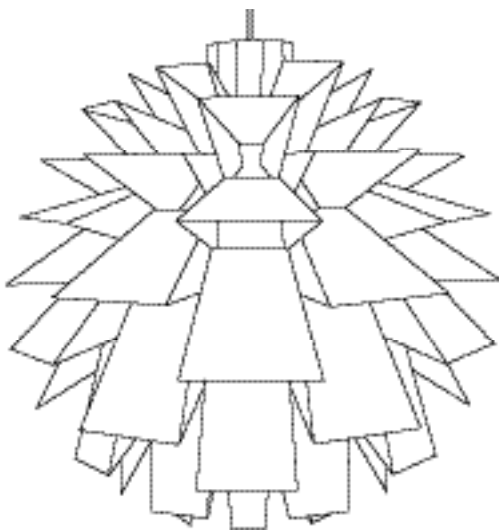

Finished lamp ready for hanging.

Hanging the lamp.

The lamp can be suspended without removing the bulb socket. Bulbs can easily be replaced via the flexible bottom of the lamp.

MAX.60 WATT

Aus 69 Teilen zu montierende Lampe. Lässt sich ohne Werkzeuge oder Klebstoff zusammenbauen. Maximale Nutzung des Lichteffekts; völlig blendfrei. **Achtung!** Es ist von entscheidender Bedeutung, dass die Bauteile in der richtigen Reihenfolge montiert werden. Entnehmen Sie der Packung deshalb jeweils nur einen Satz Bauteile!

Alle Bauteile sind mit der matten Seite nach außen zu montieren.

1.

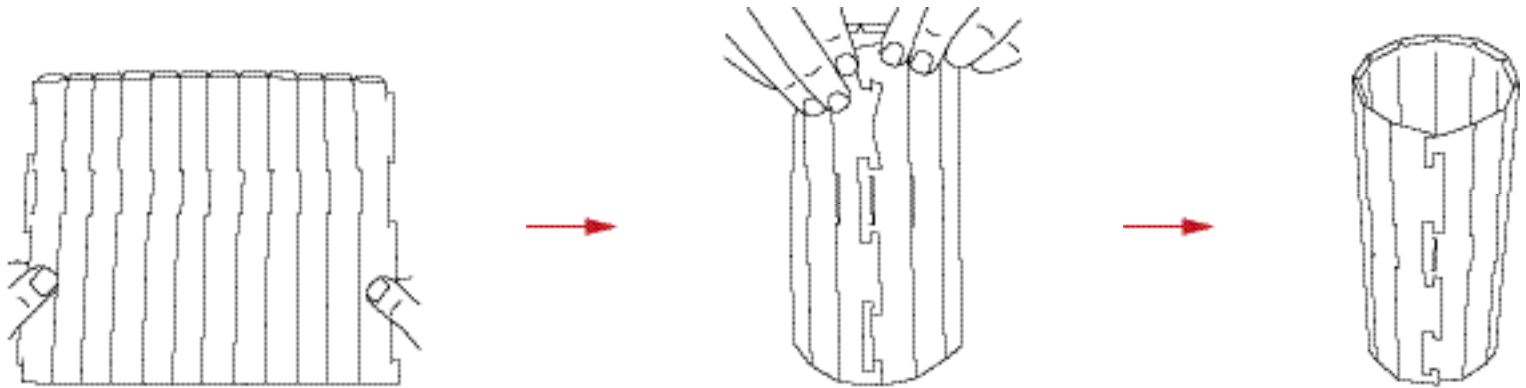

Den Sockel zu einem 12-eckigen Zylinder "zusammenknipsen".
Geknickter Rand nach oben.

2.

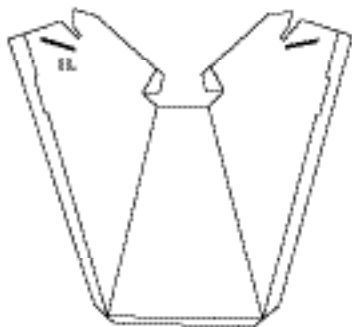

6 Bauteile Nr. 11 aus der Packung nehmen.
Überflüssiges Material in den zwei Schlitten
herausstechen.

3.

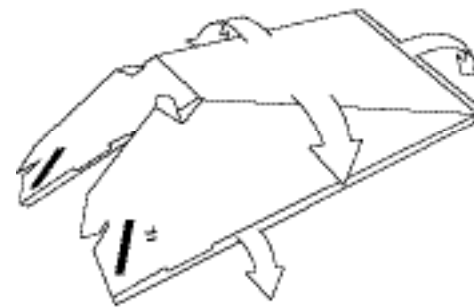

Die Bauteile falten, wie abgebildet.
Verstärkungsänder ganz einbiegen.

4.

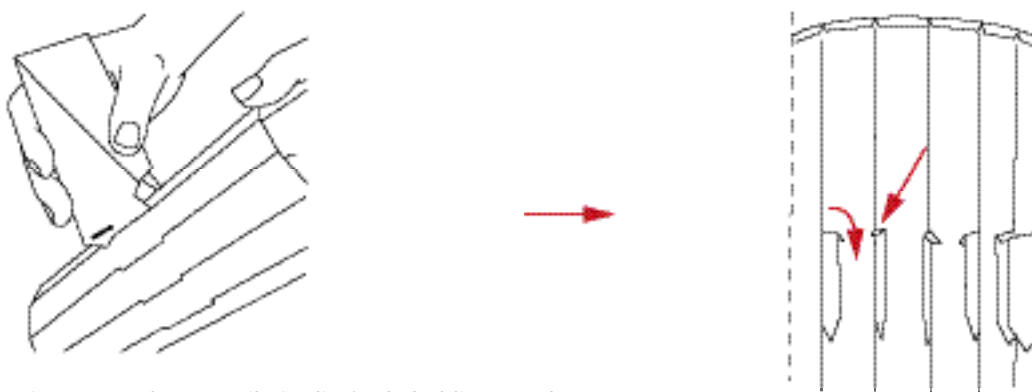

Die Lappen der Bauteile in die Sockelschlitzte stecken
und die Zipfel an der Innenseite ausrichten.

5.

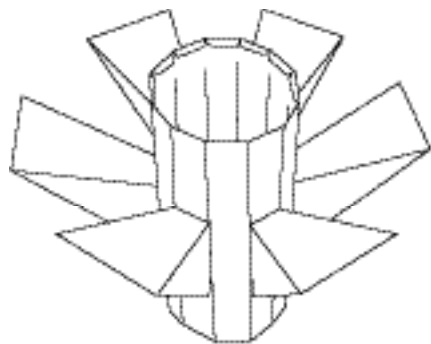

Sockel mit angehefteten Bauteilen Nr. 11.
Auf den Kopf stellen.
6 Bauteile Nr. 10 wie die Bauteile Nr. 11 falten.

6.

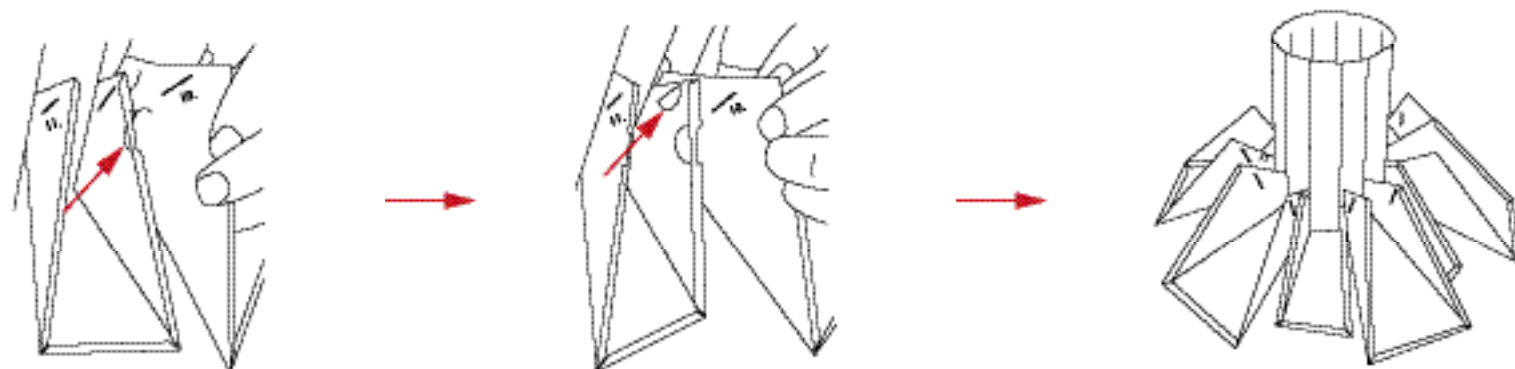

6 Bauteile Nr. 10 gemäß der Abbildung
an die Bauteile Nr. 11 anhängen.

7.

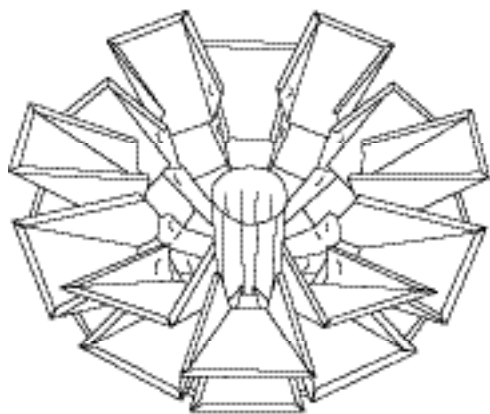

Ebenso je 6 Bauteile Nr. 9, Nr. 8
und Nr. 7 falten und einhängen.

8.

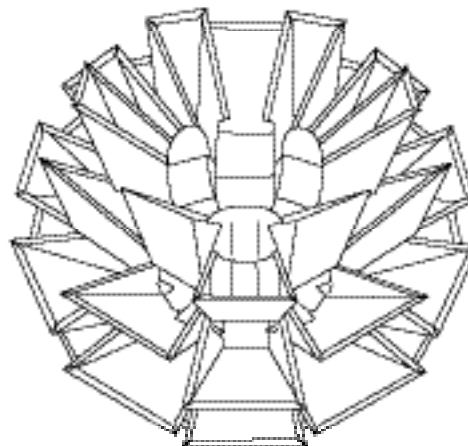

Ebenso je 6 Bauteile Nr. 6, Nr. 5
und Nr. 4 falten und einhängen.

9.

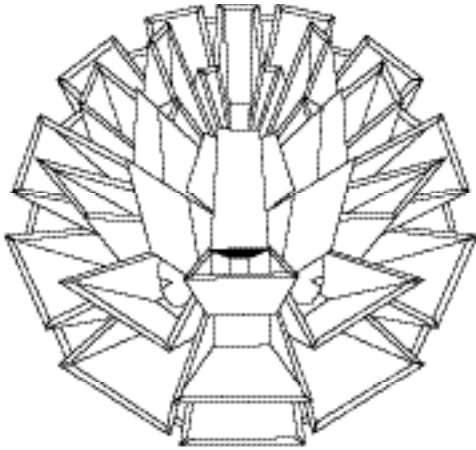

Zuletzt je 6 Bauteile Nr. 3, Nr. 2 und Nr. 1 falten und einhaken.

10.

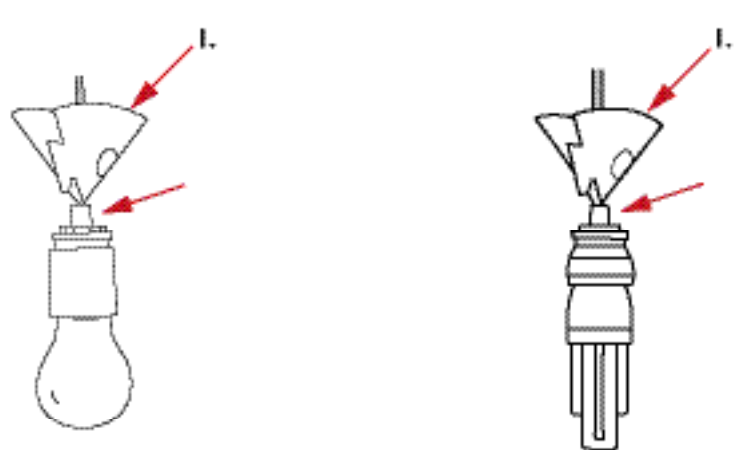

Das erste Aufhängungselement um das Kabel herum "zusammenknipsen" – die Spitze nach unten. **WICHTIG!** Zwischen der Fassung und dem Aufhängungselement muss ein Abstand sein. Deshalb **MUSS** der beiliegende Nippel gemäß der Abbildung am Kabel montiert werden.

11.

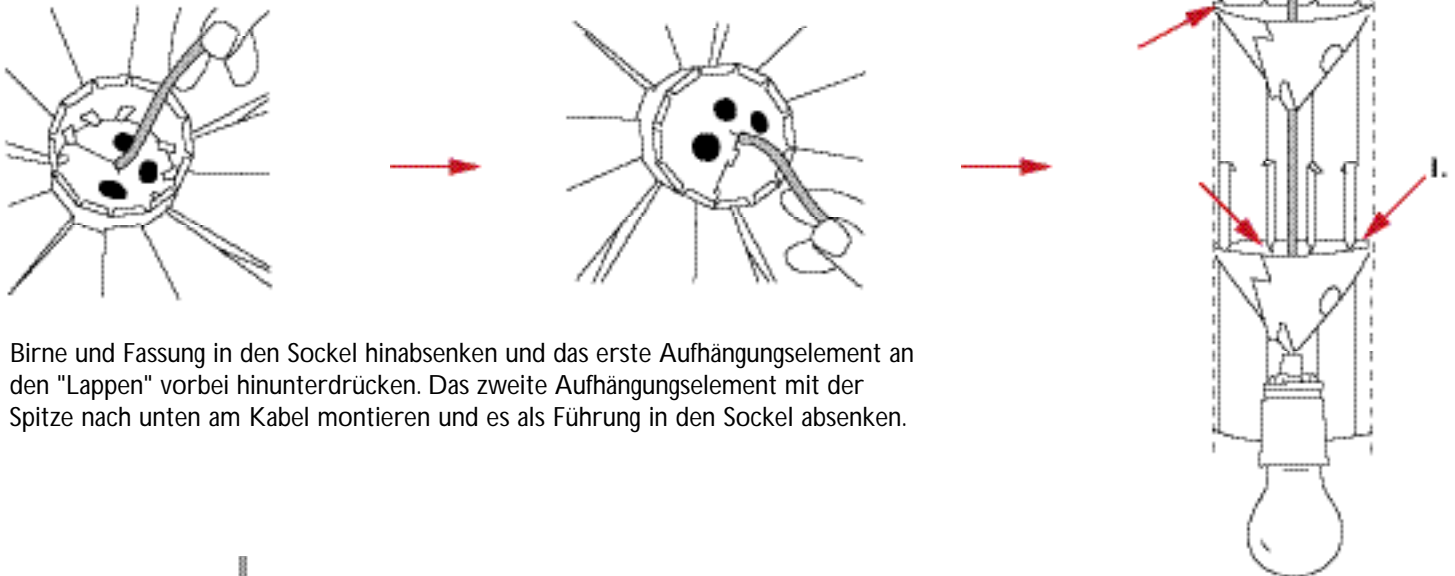

Birne und Fassung in den Sockel hinabsenken und das erste Aufhängungselement an den "Lappen" vorbei hinunterdrücken. Das zweite Aufhängungselement mit der Spitze nach unten am Kabel montieren und es als Führung in den Sockel absenken.

12.

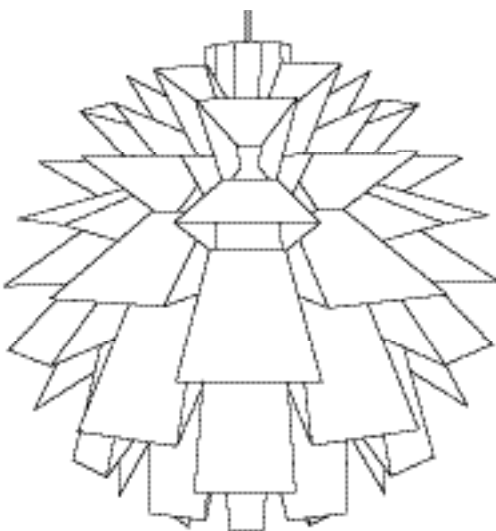

Die Lampe ist fertig, bereit zum Aufhängen.

Das Aufhängen der Lampe

Die Lampe kann aufgehängt werden, ohne die Lampenfassung abzumontieren. Das Auswechseln der Birne kann mit Leichtigkeit durch den flexiblen Boden der Lampe erfolgen.

MAX.60 WATT

INSTRUCTIONS D'ASSEMBLAGE NORM 69/FRANÇAIS

La lampe en 69 éléments à assembler ne requiert aucun outil ni colle. Totalement anti-éblouissante, elle exploite au maximum l'effet lumineux.
Attention! Il est impératif d'assembler les éléments dans le bon ordre. Par conséquent, ne sortir qu'un seul jeu d'éléments à la fois de l'emballage.

Tous les éléments doivent être assemblés avec la face mate orientée vers l'extérieur.

1.

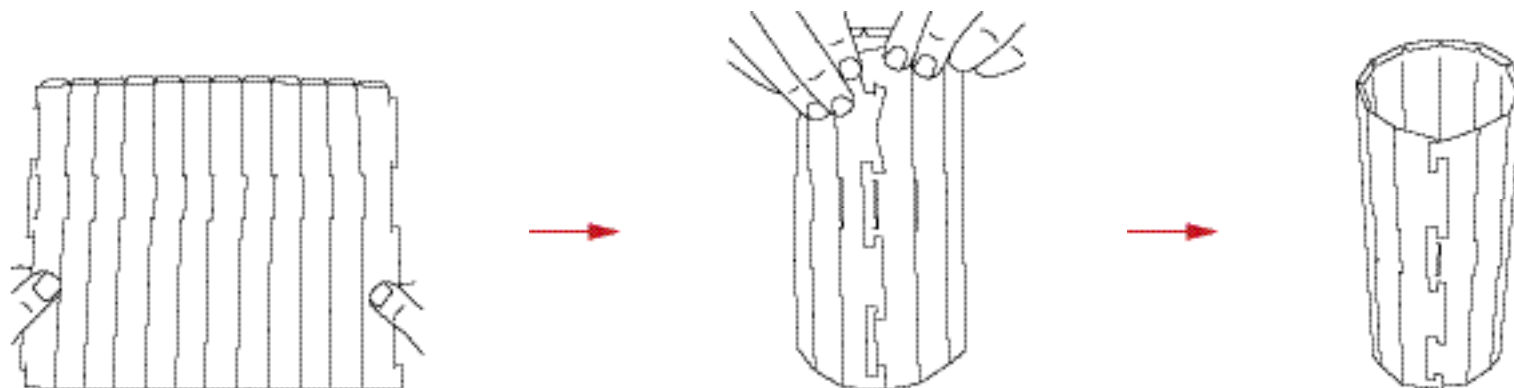

« Enrouler » le socle de façon à former un cylindre dodécagonal. Orienter le bord replié vers le haut.

2.

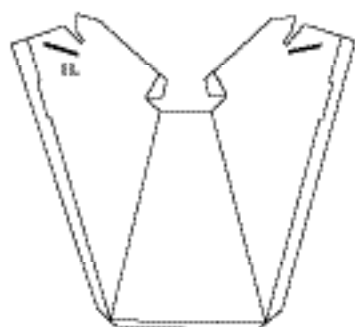

Ôter de l'emballage les 6 éléments marqués du nombre « 11 ». Dégager le matériau superflu dans les deux rainures.

3.

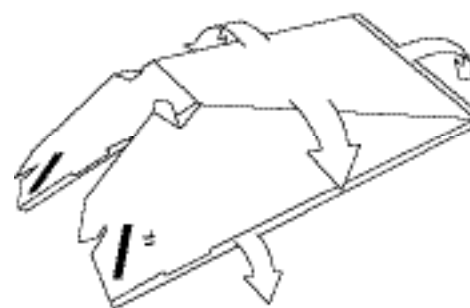

Plier les éléments comme illustré. Replier totalement les renforts.

4.



Insérer l'onglet des éléments dans les rainures du socle et rabattre les bouts à l'intérieur du socle.

5.

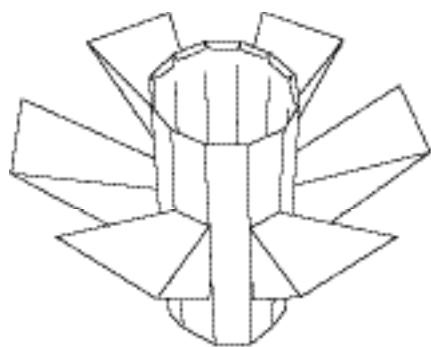

Retourner le socle avec les éléments « 11 »
assemblés. Plier les 6 éléments « 10 » de la
même façon que les éléments « 11 ».

6.

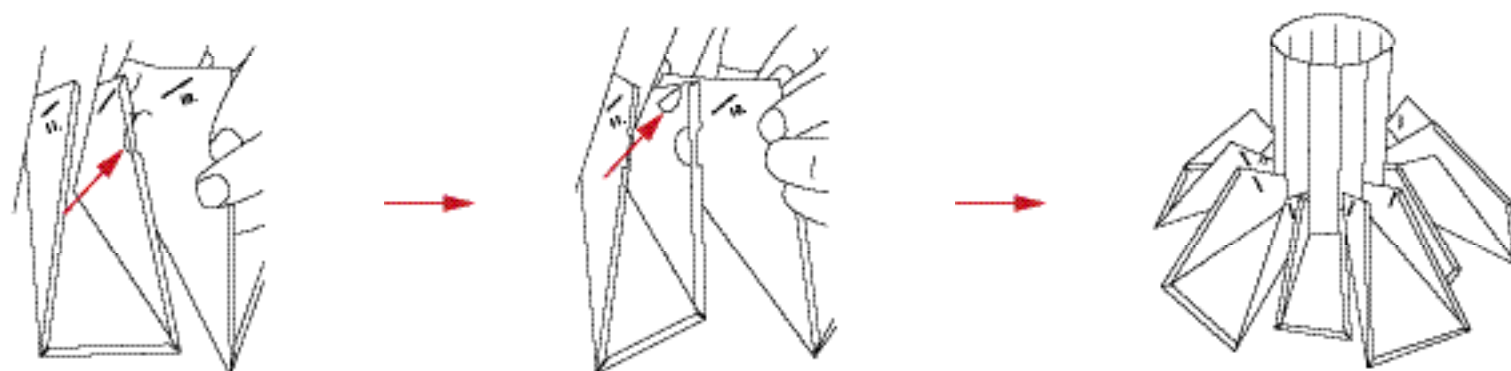

Monter les 6 éléments « 10 » sur les
éléments « 11 », comme illustré.

7.

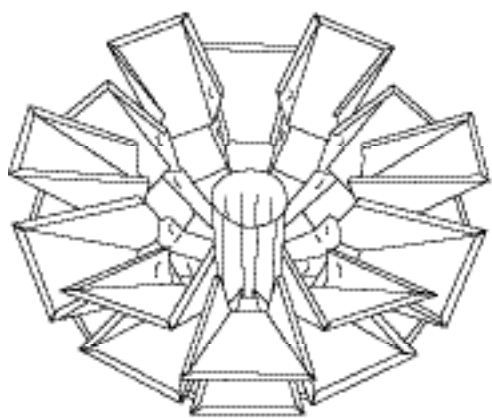

Procéder de la même façon pour plier et
monter les 6 éléments « 9 », « 8 » et « 7 ».

8.

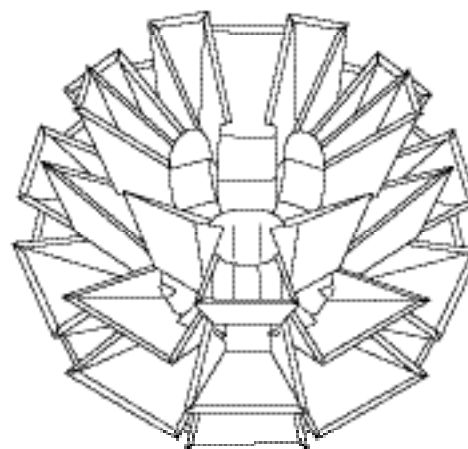

Procéder de la même façon pour plier et
monter les 6 éléments « 6 », « 5 » et « 4 ».

9.

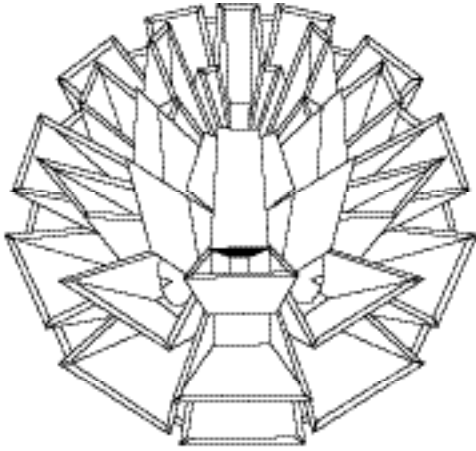

Finalement, plier et monter les 6 éléments « 3 », « 2 » et « 1 ».

10.

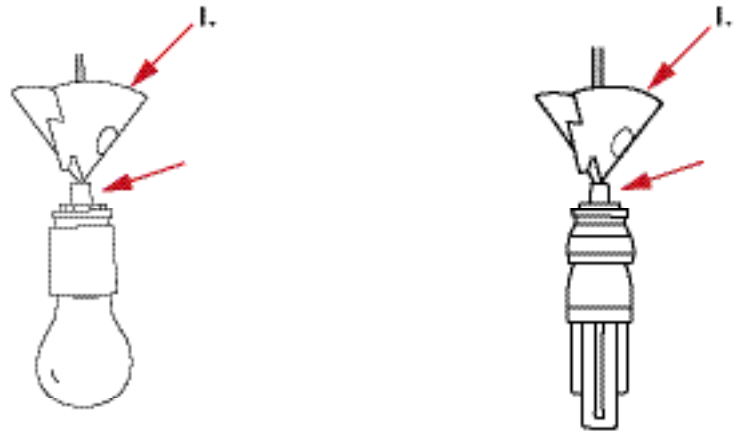

« Enrouler » le premier élément de suspension autour du câble, en orientant la pointe vers le bas. **ATTENTION!** Il est impératif de conserver un certain écart entre la douille et l'élément de suspension. Le raccord livré **DOIT** donc être monté sur le câble, comme indiqué sur le croquis.

11.

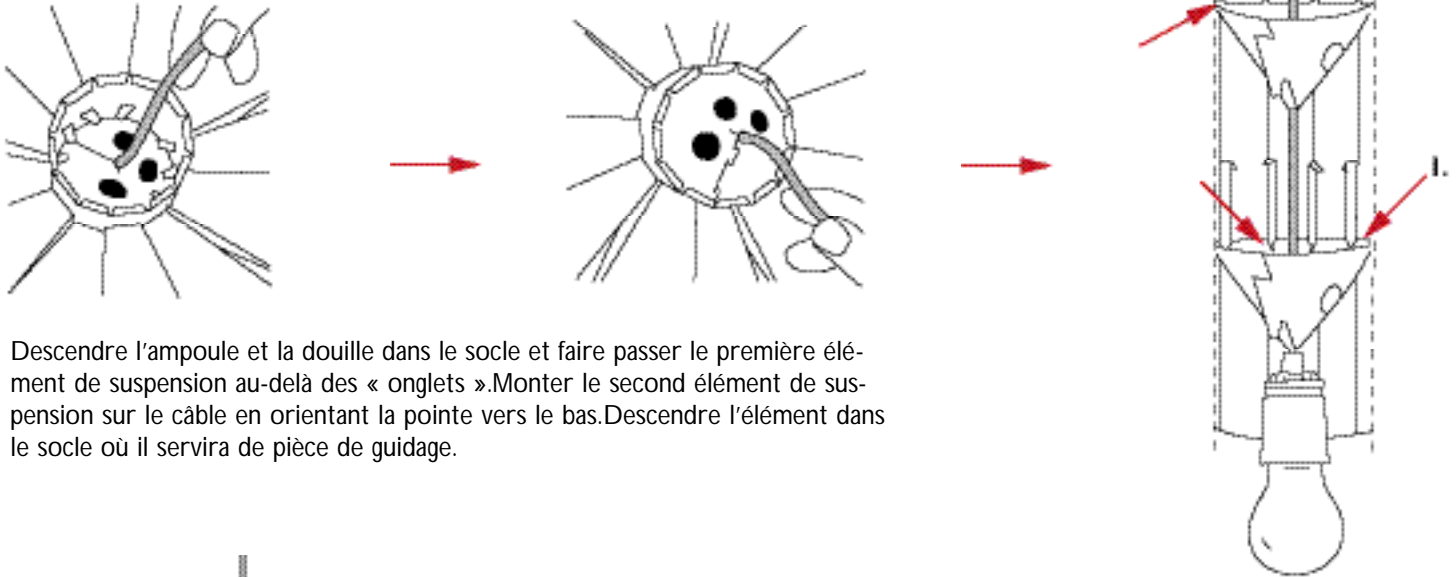

Descendre l'ampoule et la douille dans le socle et faire passer le premier élément de suspension au-delà des « ongles ». Monter le second élément de suspension sur le câble en orientant la pointe vers le bas. Descendre l'élément dans le socle où il servira de pièce de guidage.

12.

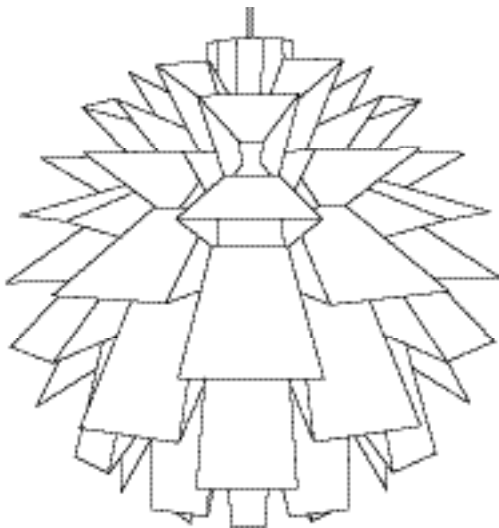

Finie, la lampe est maintenant prête à être suspendue.

Suspension de la lampe

La lampe peut être suspendue sans qu'il soit nécessaire de démonter la douille.
L'ampoule peut être facilement remplacée via le fond souple de la lampe.

MAX.60 W

Lámpara de 69 piezas para ensamblar sin necesidad de herramientas ni pegamento. Máximo aprovechamiento del efecto luminoso. Completamente antideslumbrante. **Atención:** Es decisivo ensamblar las piezas en el orden indicado, por lo que hay que sacar los distintos juegos de piezas uno a uno.

Todas las piezas han de ensamblarse con el lado mate hacia afuera.

1.

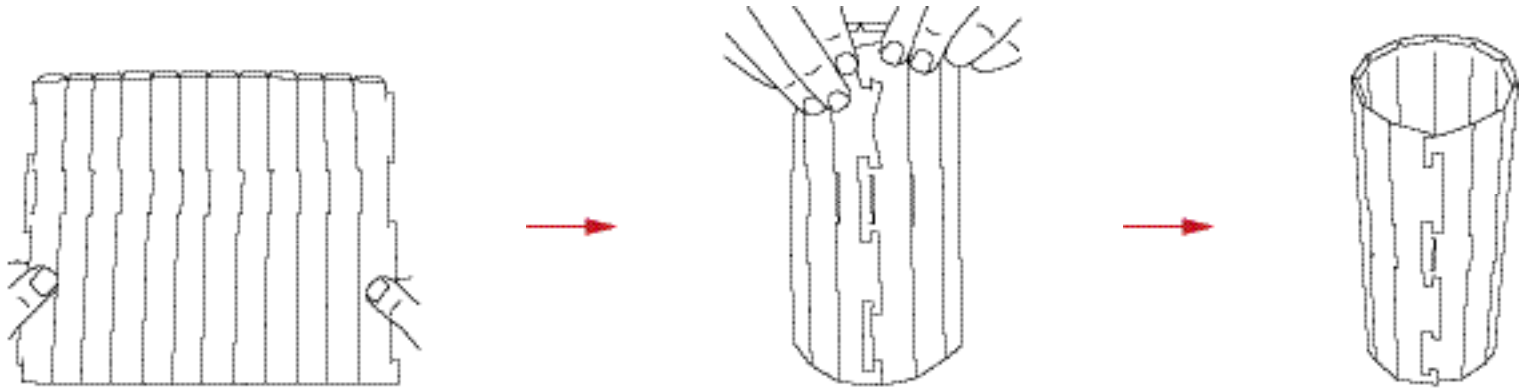

Enrollar y enganchar el soporte formando un cilindro de 12 lados con la parte de las pestañas hacia arriba.

2.

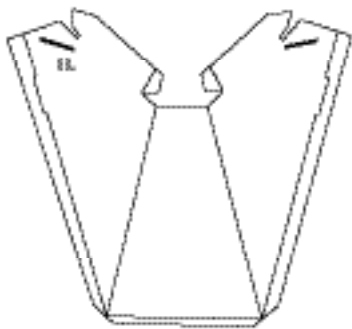

Sacar las 6 piezas marcadas con '11'.
Extraer el material sobrante de las dos ranuras.

3.

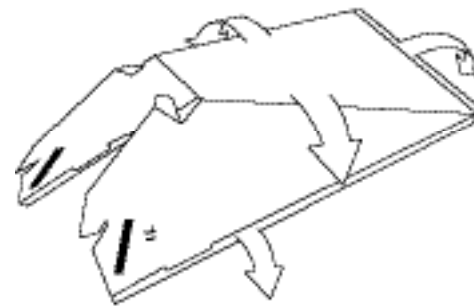

Plegar las piezas como se indica.
Doblar completamente las pestañas de refuerzo.

4.

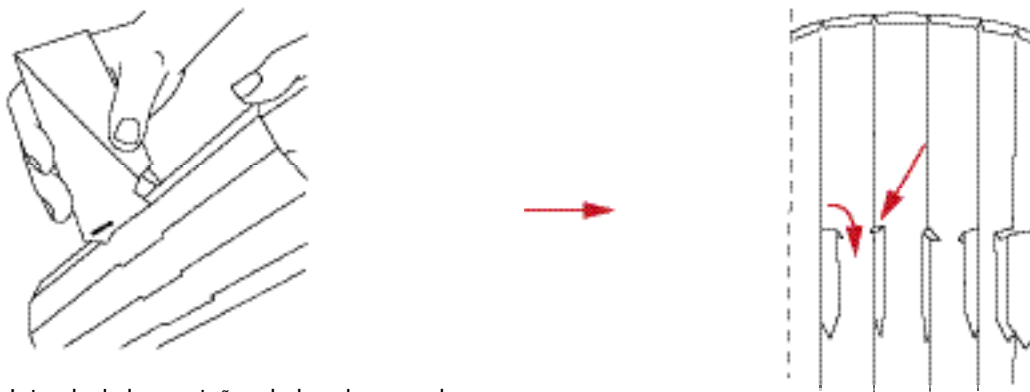

Introducir las pestañas de las piezas en las ranuras del soporte ajustándolas desde la cara interior.

INSTRUCCIONES DE MONTAJE NORM 69/ESPAÑOL

5.

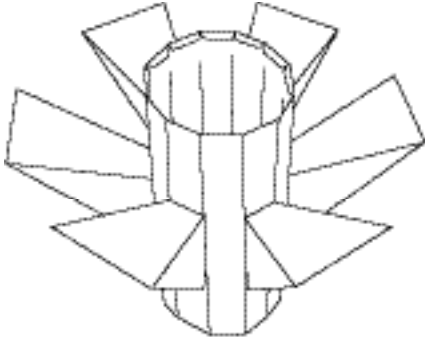

Soporte con las piezas '11' fijadas.
Dar la vuelta al soporte.
Doblar las 6 piezas marcadas con '10'
de igual forma que las piezas '11'.

6.

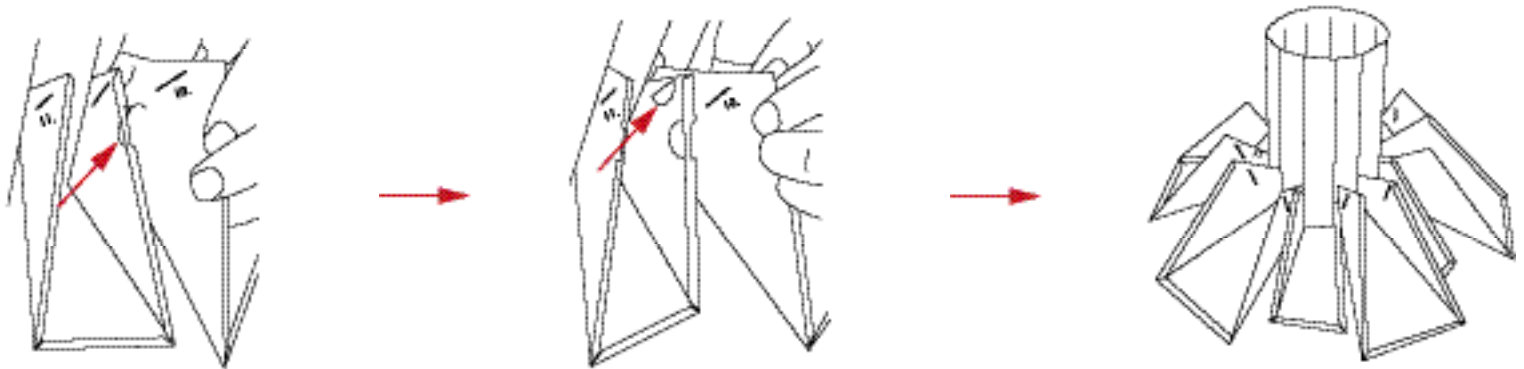

Acoplar las 6 piezas '10' en las piezas
'11' como se muestra en la ilustración.

7.

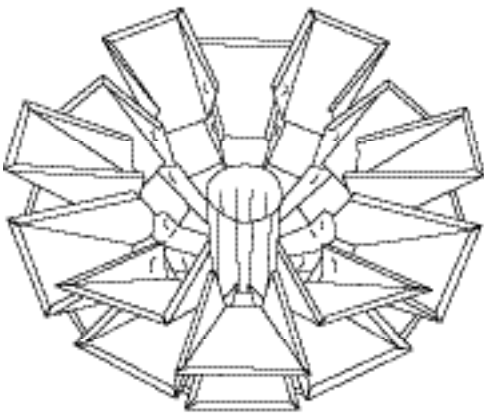

Doblar y acoplar las 6 piezas
'9','8' y '7' de la misma forma.

8.

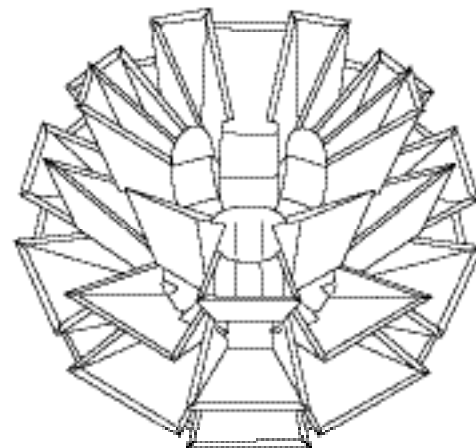

Doblar y acoplar las 6 piezas
'6','5' y '4' de la misma forma.

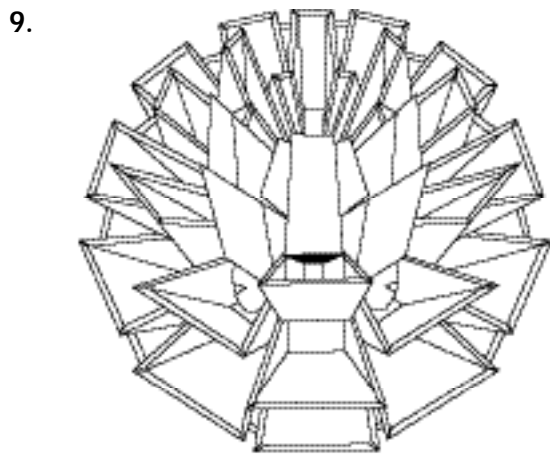

Por último, doblar y acoplar las 6 piezas '3','2' y '1'.

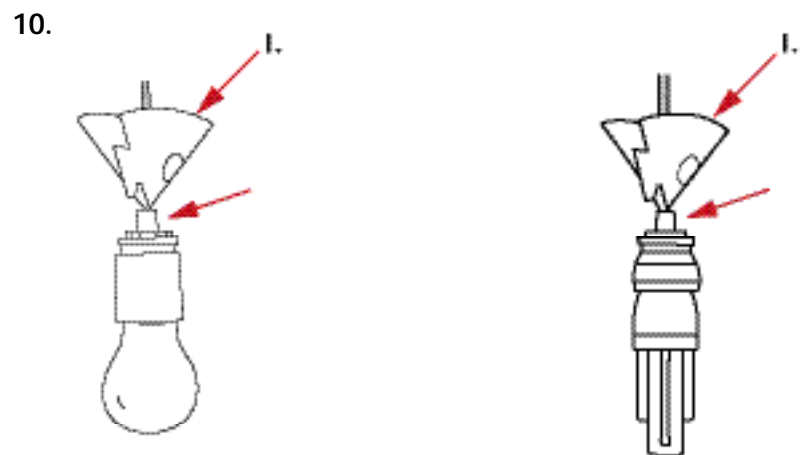

Acoplar la primera pieza suspensora alrededor del cable con el pico hacia abajo. **¡IMPORTANTE!** Hay que dejar un espacio entre el portalámparas y la pieza. Es absolutamente necesario montar la boquilla suministrada en el cable como se muestra en la ilustración.

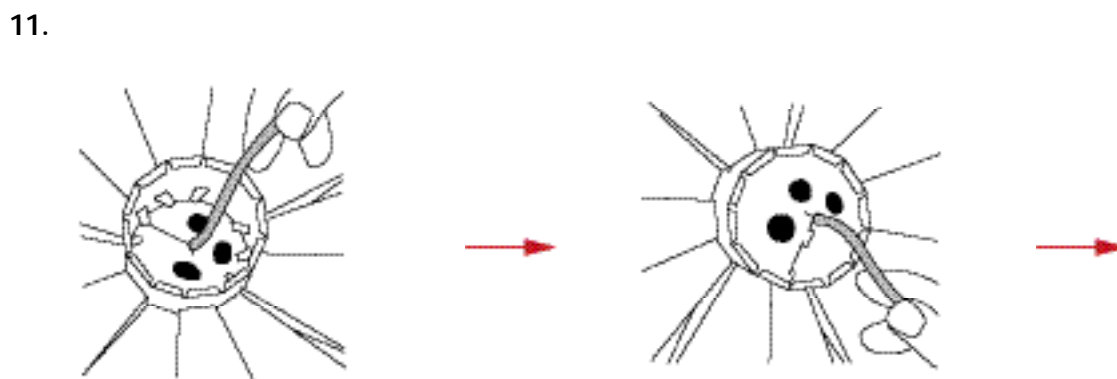

Introducir la bombilla y el portalámparas en el soporte, y presionar la primera pieza suspensora pasando por las pestañas. Ensamblar la segunda pieza suspensora en el cable con el pico hacia abajo e introducirla dentro del soporte como guía.

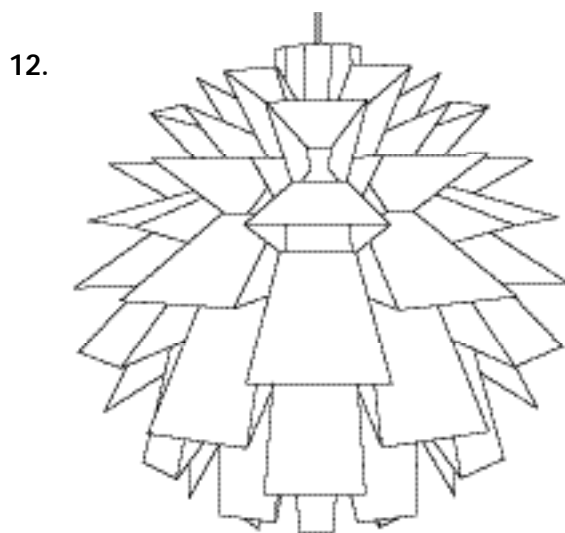
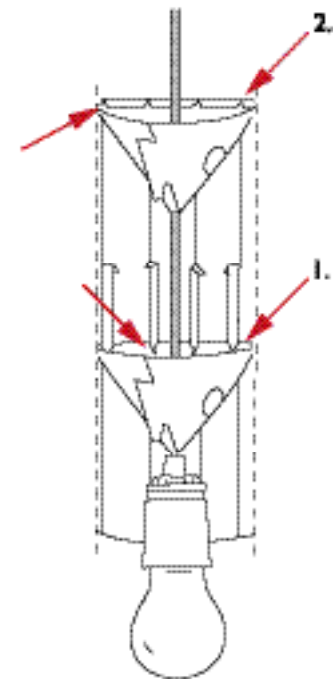

La lámpara ya está lista para colgar.

Para colgar la lámpara.

La lámpara puede colgarse sin necesidad de desmontar el portalámparas. La bombilla puede cambiarse fácilmente gracias al fondo flexible de la lámpara.

MÁX.60 WATT

ISTRUZIONI DI MONTAGGIO NORM 69/ITALIANO

Paralume in 69 elementi, da assemblare senza uso di utensili o colla. Massima luminosità, completamente antififlesso.
N.B.! È essenziale assemblare gli elementi nella sequenza corretta. Estrarre dalla confezione un solo gruppo di elementi per volta.

Tutti gli elementi devono essere montati con il lato opaco rivolto verso l'esterno.

1.

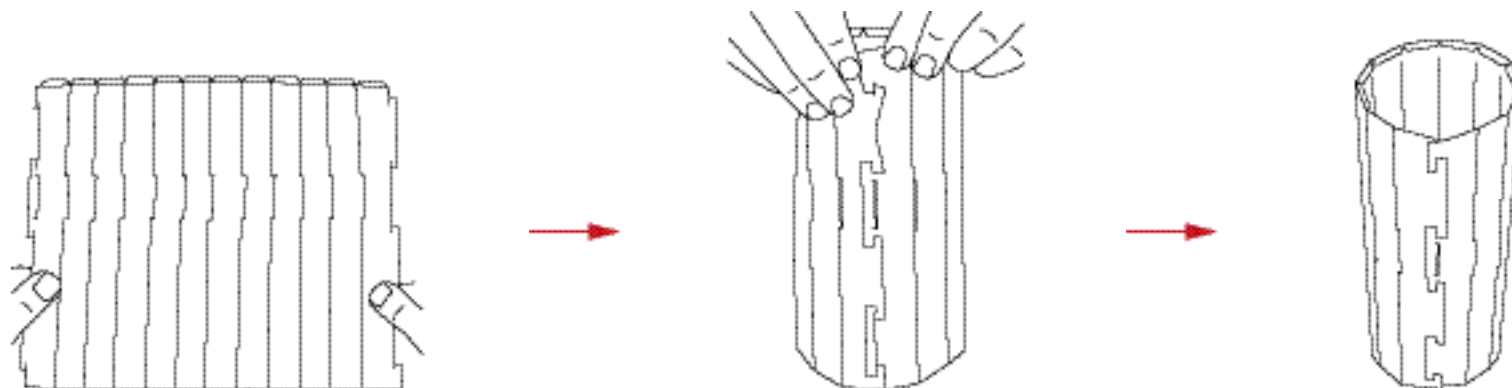

Ripiegare su se stesso l'elemento di base formando un cilindro a dodici lati. L'estremità con il bordo ripiegato all'interno deve essere rivolta verso l'alto.

2.

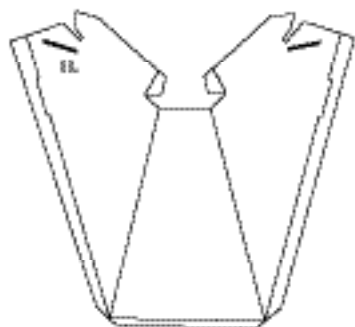

Estrarre dalla confezione 6 elementi contrassegnati dal numero '11'. Eliminare il materiale in eccesso dalle fessure.

3.

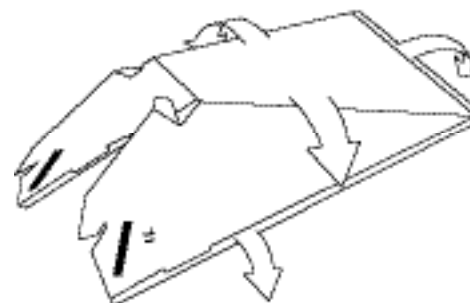

Piegare gli elementi come illustrato. Ripiegare completamente i lati di rinforzo.

4.

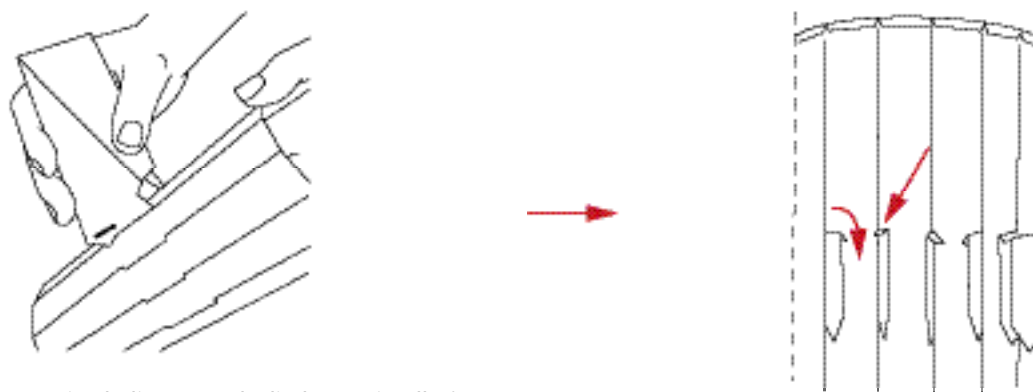

Inserire le linguette degli elementi nelle fessure dell'elemento base e dirigere i lembi all'interno.

5.

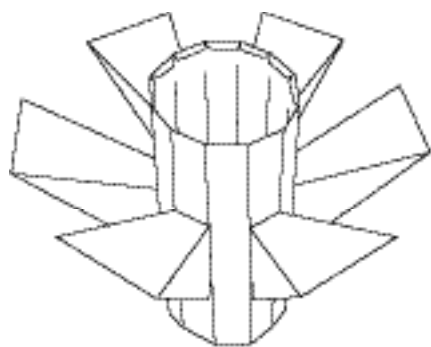

Elemento base con gli elementi numero '11' applicati.
Capovolgere. Piegare 6 elementi numero '10' secondo la
stessa procedura seguita per gli elementi numero '11'.

6.

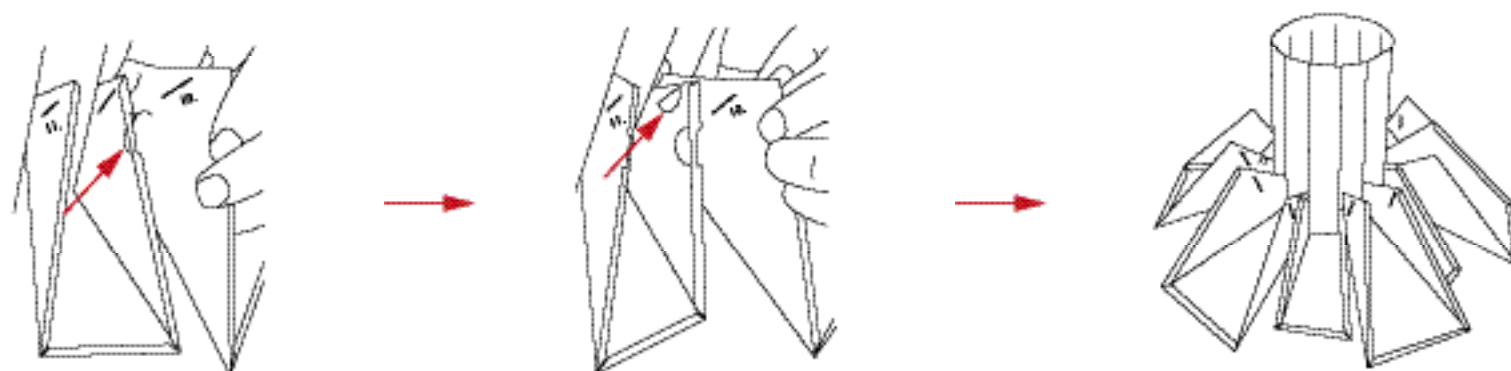

Fissare i 6 elementi numero '10' sugli
elementi numero '11' come illustrato.

7.

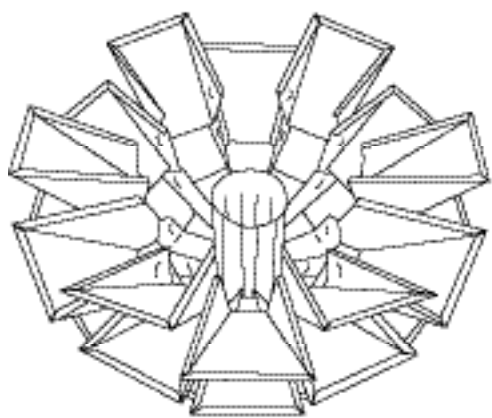

Piegare e fissare allo stesso modo
6 elementi numero '9','8' e '7'.

8.

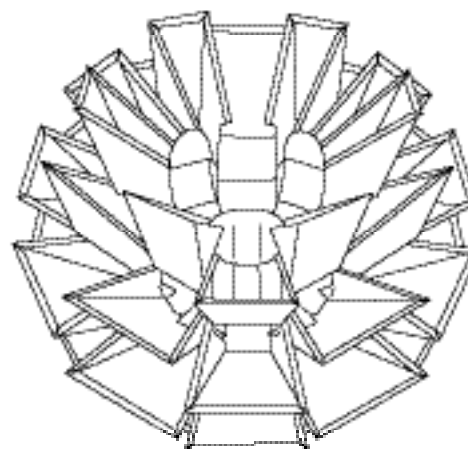

Piegare e fissare allo stesso modo
6 elementi numero '6','5' e '4'.

9.

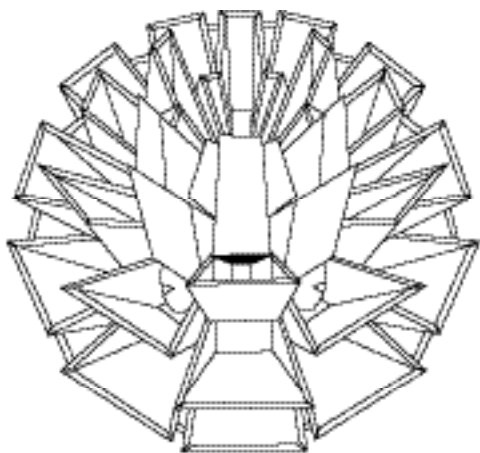

Infine piegare e fissare 6 elementi numero '3','2' e '1'.

10.

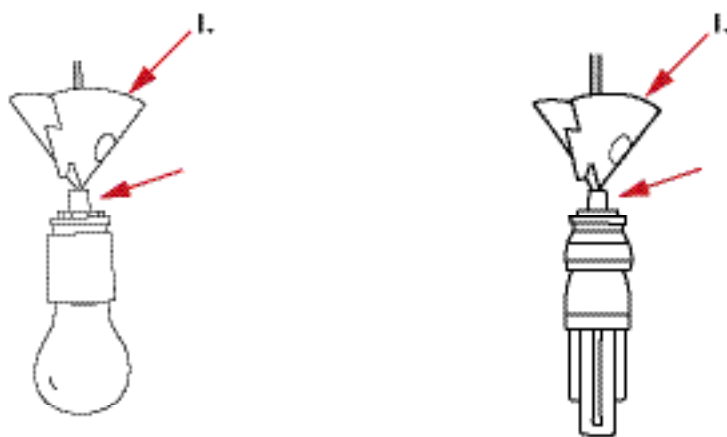

Ripiegare su se stesso il primo elemento di sospensione attorno al cavo di alimentazione, con il vertice rivolto verso il basso. **IMPORTANTE!** Il portalampada e l'elemento di sospensione devono essere distanziati. È pertanto **NECESSARIO** montare sul cavo il distanziale in dotazione come illustrato nella figura.

11.

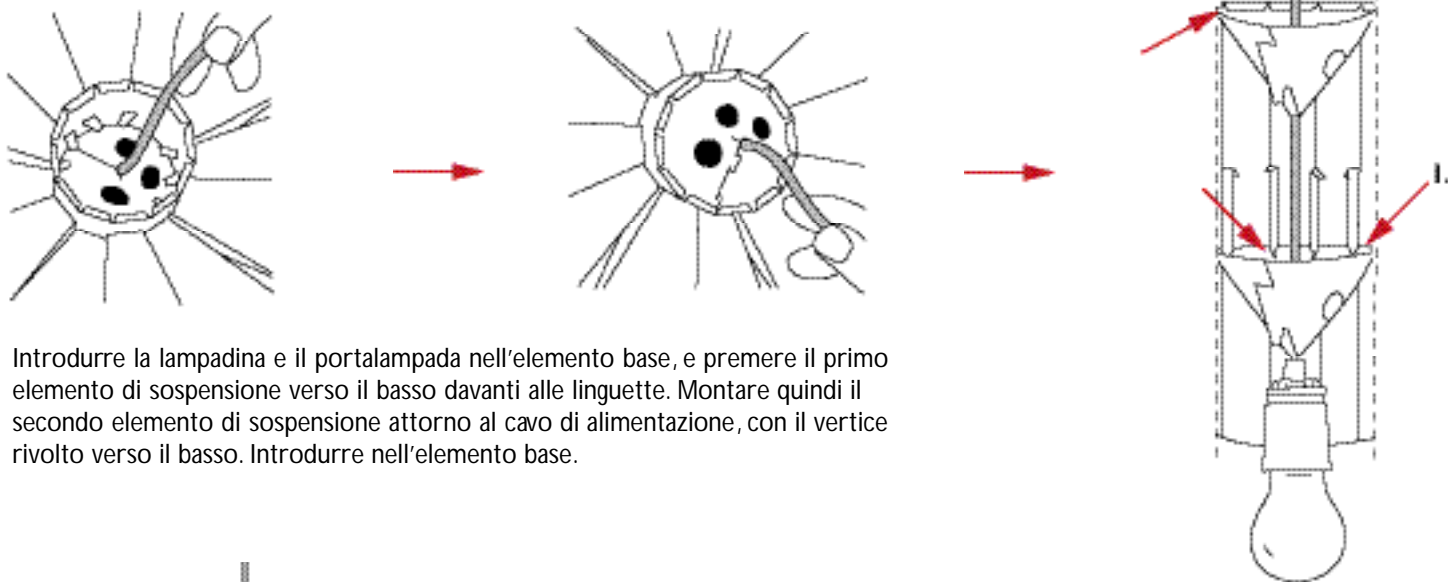

Introdurre la lampadina e il portalampada nell'elemento base, e premere il primo elemento di sospensione verso il basso davanti alle linguette. Montare quindi il secondo elemento di sospensione attorno al cavo di alimentazione, con il vertice rivolto verso il basso. Introdurre nell'elemento base.

12.

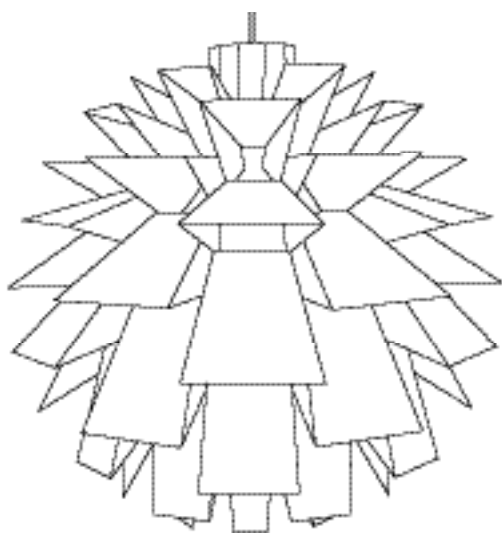

Paralume completo, pronto per l'uso.

Sospensione del paralume.

Il paralume deve essere appeso senza smontare il portalampada. Sostituire la lampadina attraverso la base flessibile del paralume.

MAKS. 60 WATT

Lamp om zelf te monteren, in 69 delen, kan gemonteerd worden zonder gereedschap of lijm, maximale benutting van lichteffect, verblindt niet. **Let op!** Het is heel belangrijk dat de elementen in de juiste volgorde gemonteerd worden. Neem daarom steeds één set elementen tegelijk uit de verpakking.

Monteer alle elementen met de matte zijde aan de buitenkant.

1.

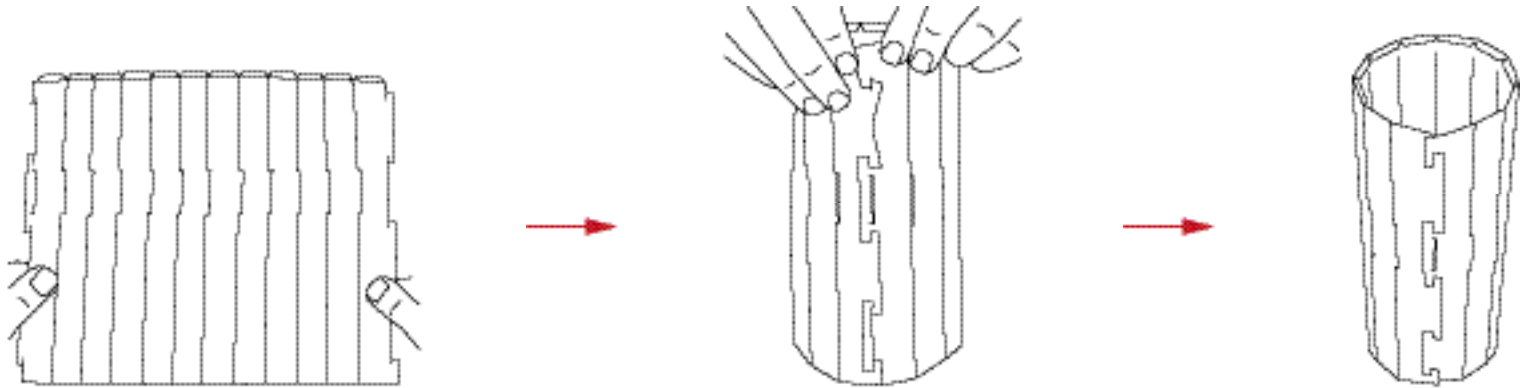

Sokkel aan elkaar 'klikken' tot een 12-zijdige cilinder. Omgebogen zijde boven.

2.

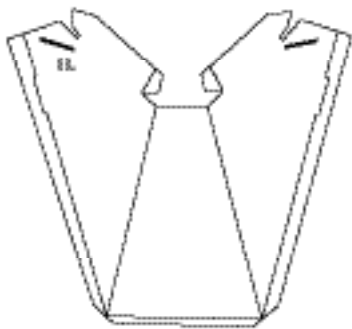

De 6 elementen met opschrift '11' uit de verpakking nemen. Overbodig materiaal in de twee sleuven verwijderen.

3.

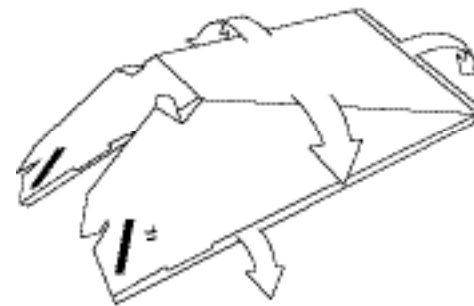

De elementen vouwen als aangegeven. De verstevigingsranden geheel ombuigen.

4.

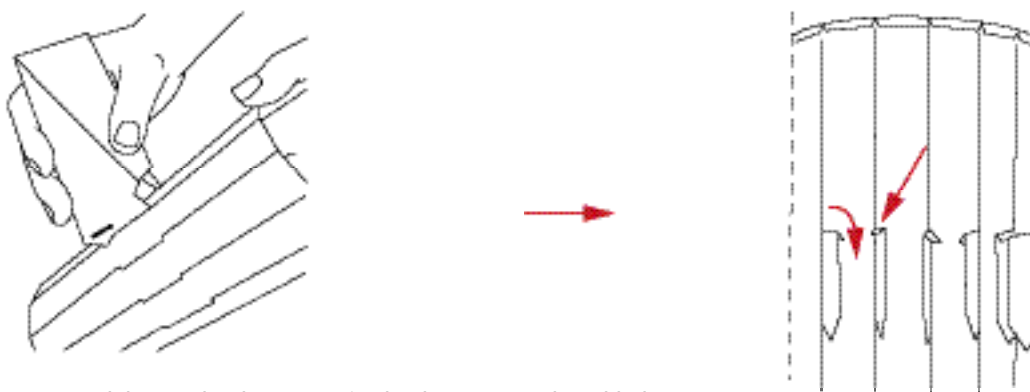

De vaandels van de elementen in de gleuven van de sokkel steken – en de uiteinden aan de binnenkant rechtop zetten.

5.

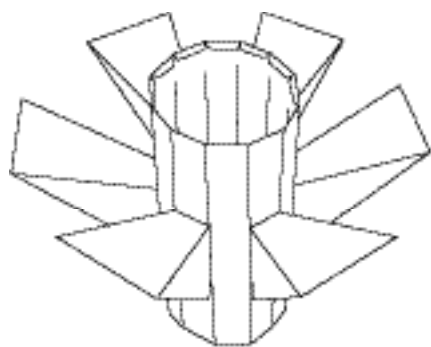

Sokkel met bevestigde '11'-elementen.
Omdraaien.
De 6 '10'-elementen vouwen als de '11'-elementen.

6.

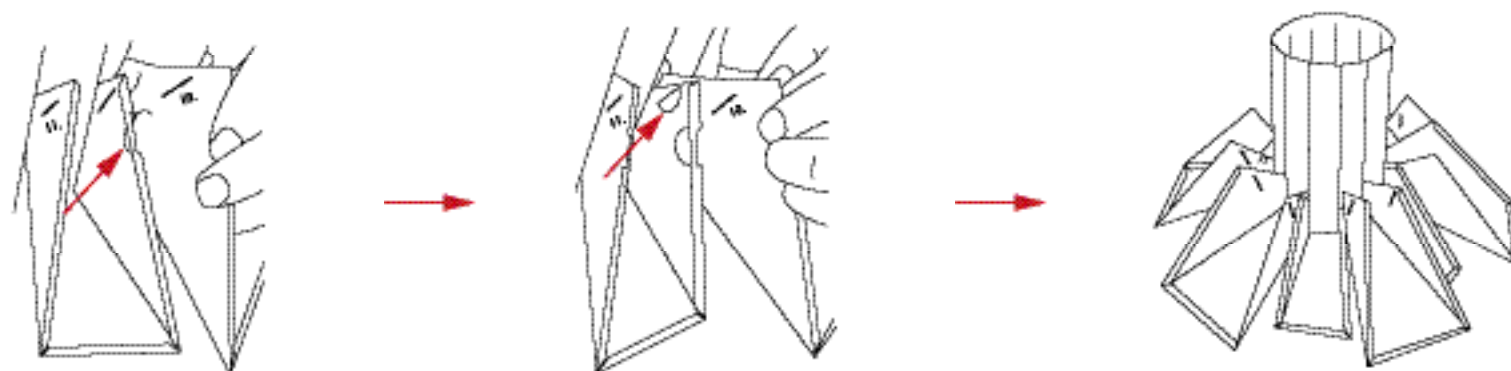

De 6 '10'-elementen aan de '11'-elementen bevestigen, zoals aangegeven.

7.

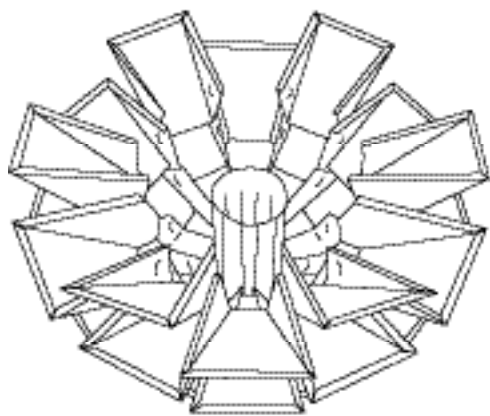

De 6 '9'-, '8'- en '7'-elementen op dezelfde wijze vouwen en bevestigen.

8.

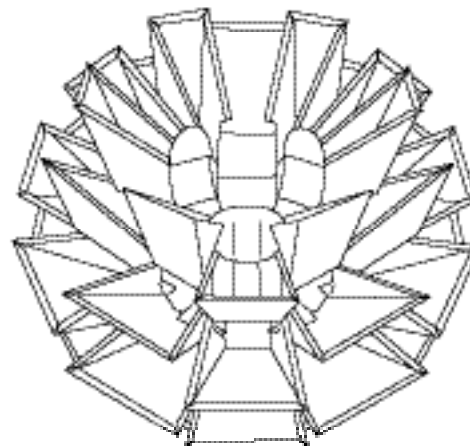

De 6 '6'-, '5'- en '4'-elementen op dezelfde wijze vouwen en bevestigen.

9.

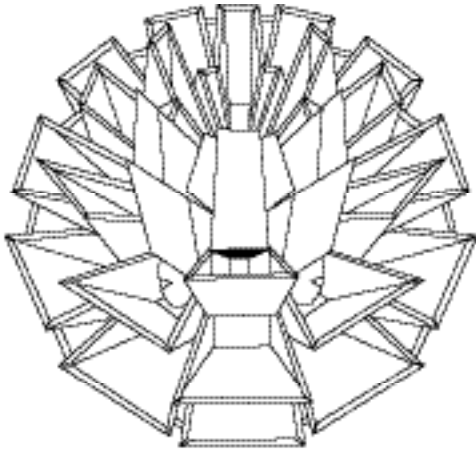

Als laatste de 6 '3'-, '2'- en '1'-elementen vouwen en bevestigen.

10.

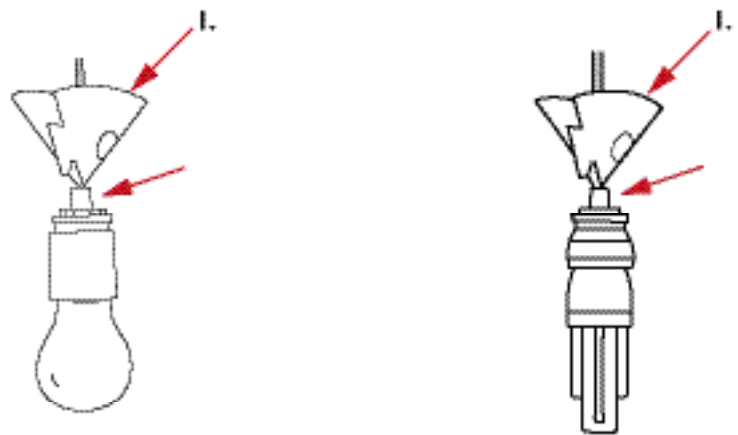

Het eerste ophangelement om het snoer 'klikken'. **BELANGRIJK!** Er moet ruimte zijn tussen de fitting en het ophangelement. Daarom **MOET** de bijgevoegde nippel op het snoer gezet worden, zoals aangegeven in de tekening.

11.

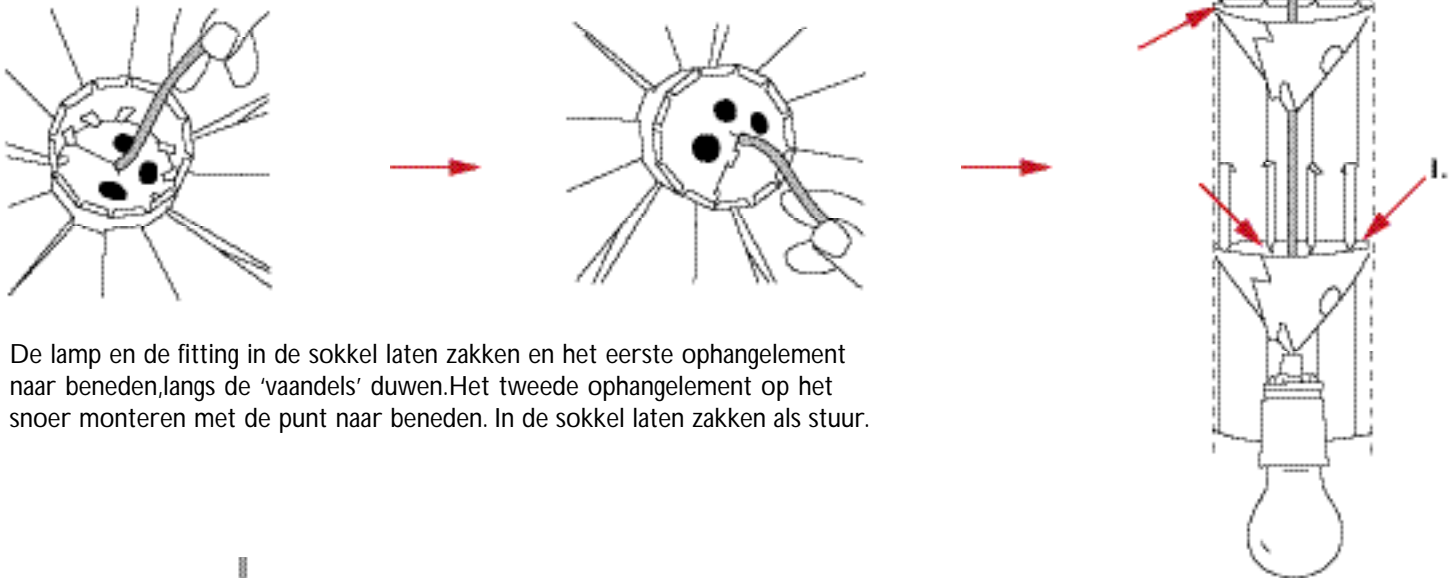

De lamp en de fitting in de sokkel laten zakken en het eerste ophangelement naar beneden, langs de 'vaandels' duwen. Het tweede ophangelement op het snoer monteren met de punt naar beneden. In de sokkel laten zakken als stuur.

12.

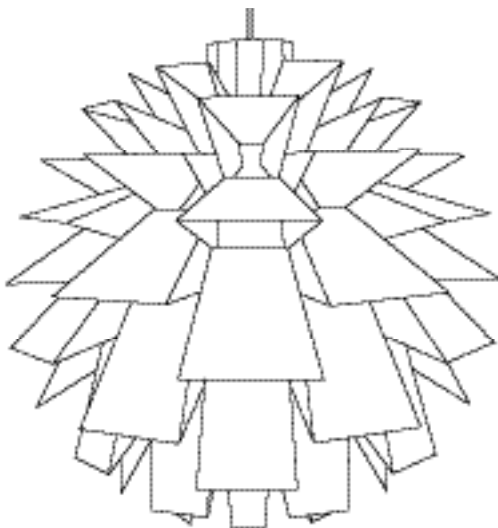

De lamp is nu klaar om op te hangen.

Het ophangen van de lamp.

U kunt de lamp ophangen zonder de fitting te verwijderen. Het verwisselen van een lamp gaat makkelijk door de flexibele onderkant.

MAX.60 WATT

规格69组装指南/中文

整套灯具共有69个元件。组装时无需使用工具或胶水，光线利用率最大，完全不浪费。
注意：按照正确顺序组装元件极为重要。因而在组装时，每次只应取出一组元件。

所有元件组装时，粗糙面都应朝外。

1.

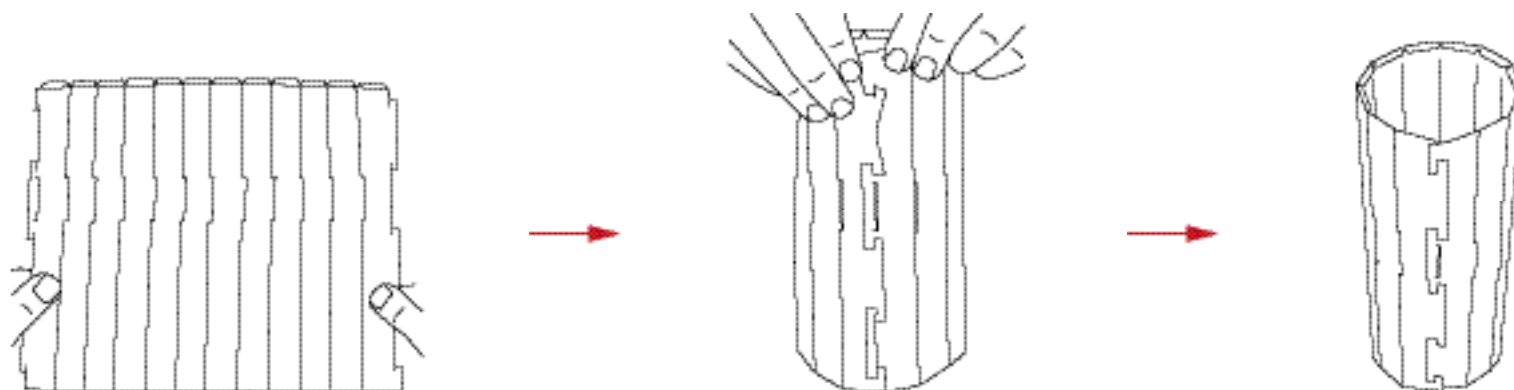

将中心元件卡在一起，形成一个以圆的柱体。
折叠边应位于最上端。

2.

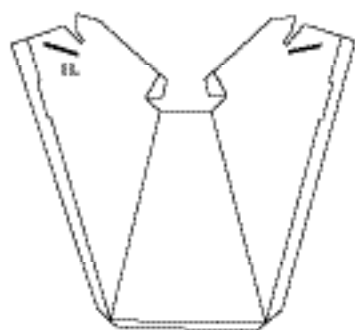

从包装中取出六个标有“11”的元件。
剪除两条折缝中间的多余材料。

3.

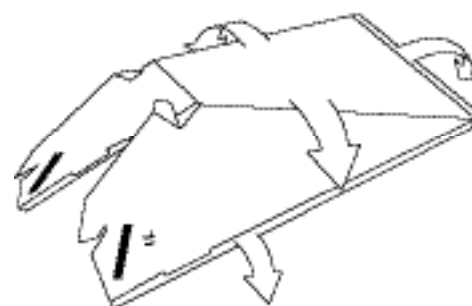

如图所示，折叠元件。
把加强边向上折叠在一起。

4.

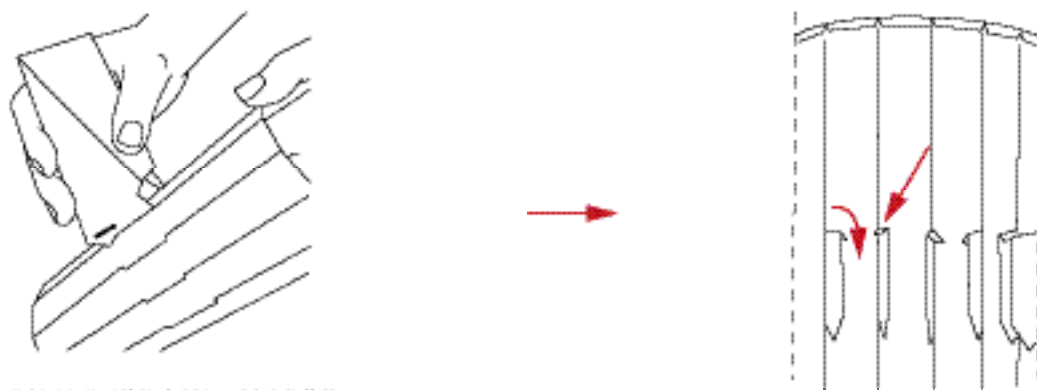

将折叠好的元件的舌片插入到中心柱体的
缝隙中，并剪掉伸入圆柱内部的部分。

5.

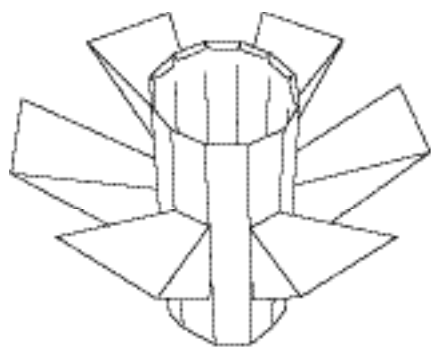

将六个标有“11”的元件固定在柱体上，将柱体侧置，取出六个标有“10”的元件，采用与标有“11”元件相同的方法折叠。

6.

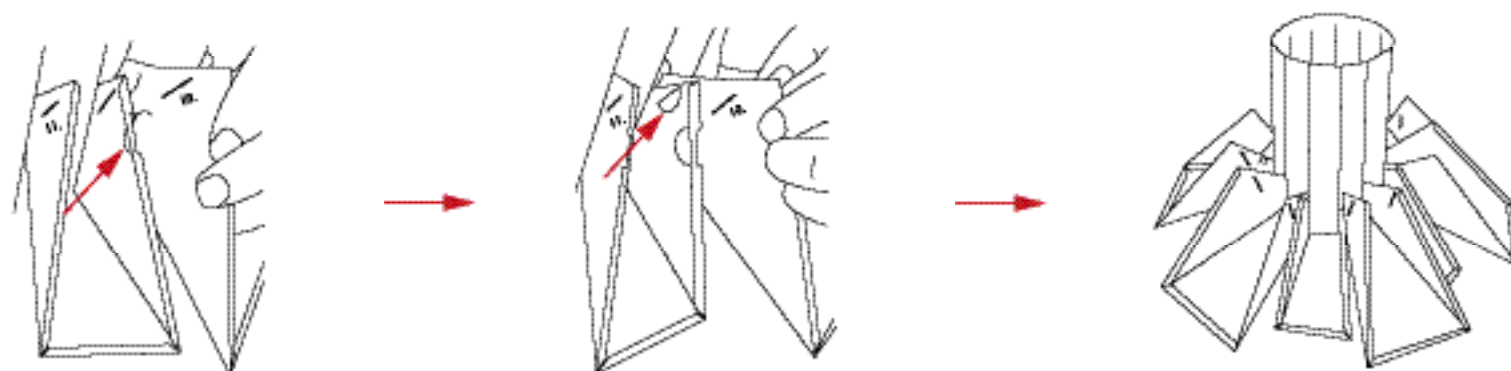

如图所示，将六个标有“10”的元件固定在标有“11”的元件上。

7.

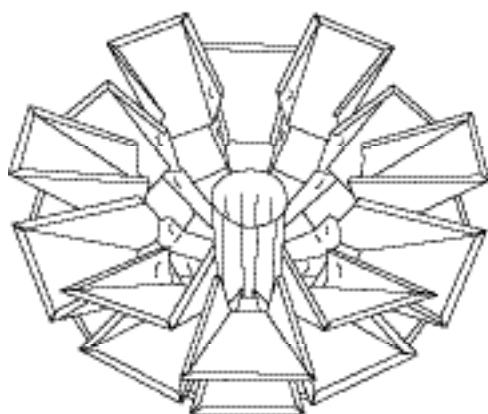

如上所述，分别折叠和固定六个标有“9”、“8”、“7”的元件。

8.

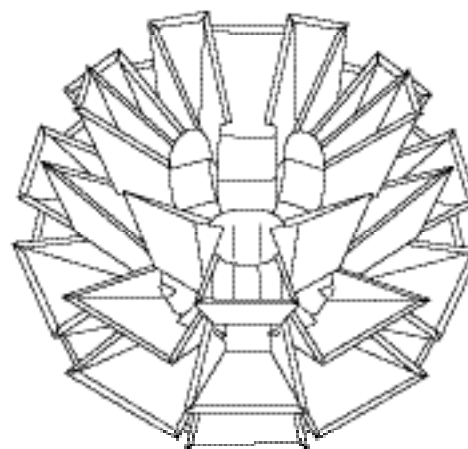

如上所述，分别折叠和固定六个标有“6”、“5”、“4”的元件。

9.

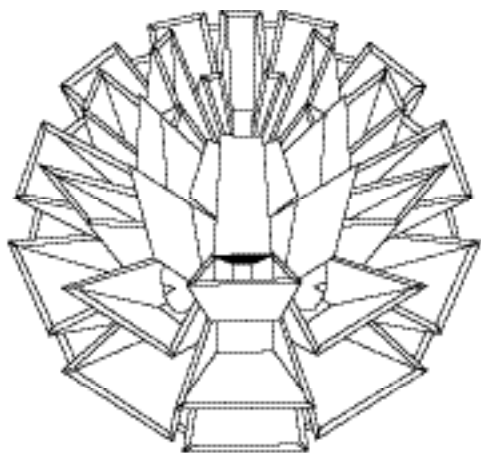

最后，折叠并固定六个标有“3”、“4”、“5”的元件。

10.

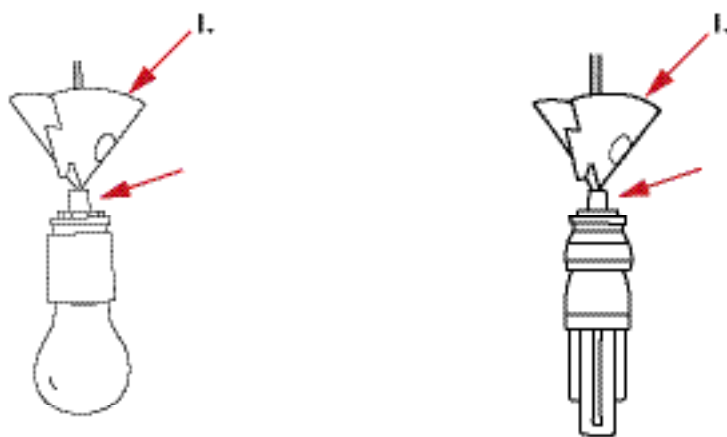

将第一个悬挂元件卡在相应的电线上，悬挂元件顶端冲下。
注意：在灯泡接口和悬挂元件间必须留有间隙，因此相应的垫片必须按照图示方法安装到电线上。

11.

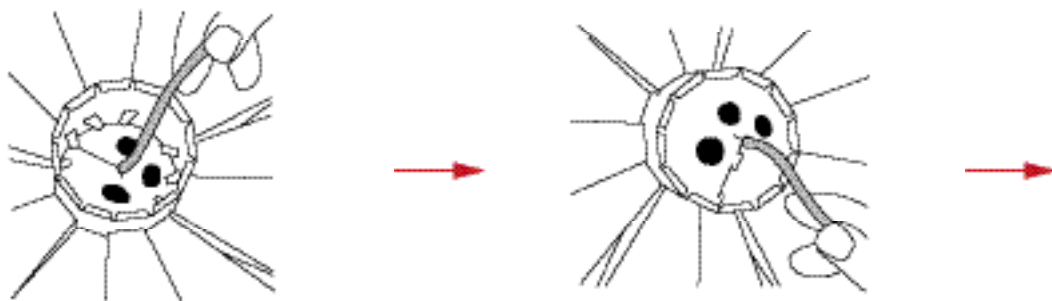

将灯泡和灯泡接口放入柱体，然后按下第一个悬挂元件直至越过“舌片”。将第二个悬挂元件安装到电线上，顶端冲下，然后将其放入柱体中，以确保灯具可垂直悬挂。

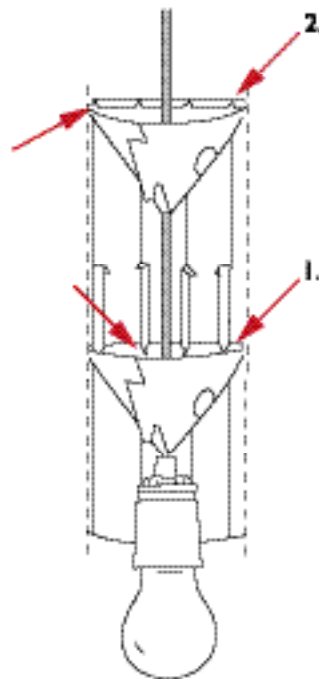

12.

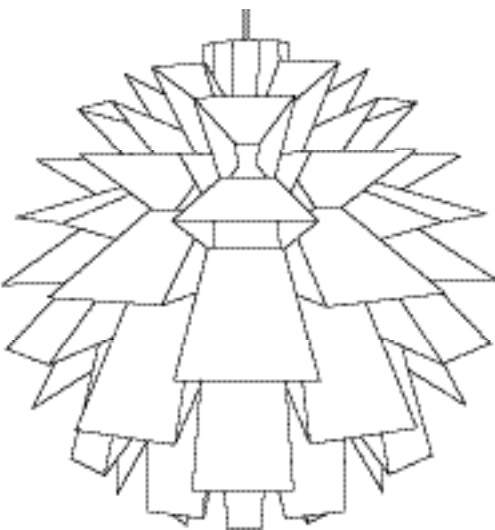

灯具已组装完毕，可供悬挂。

悬挂灯具
无需卸下灯泡接口，即可悬挂灯具。
可旋转的灯具底座将使灯泡更换方便简单。

最大功率0.5W

組み立てランプは89の部品から成っており、工具や接着剤なしで組み立て可能で最大照明効果があり、まぶしさは全然ありません。
 注！エレメントを正しい順序で組み立てることがとても大切です。ですからケースからはエレメントを一組ずつのみ出してください。

エレメントはすべて光沢なしの面を外側に向けて組み立ててください。

1.

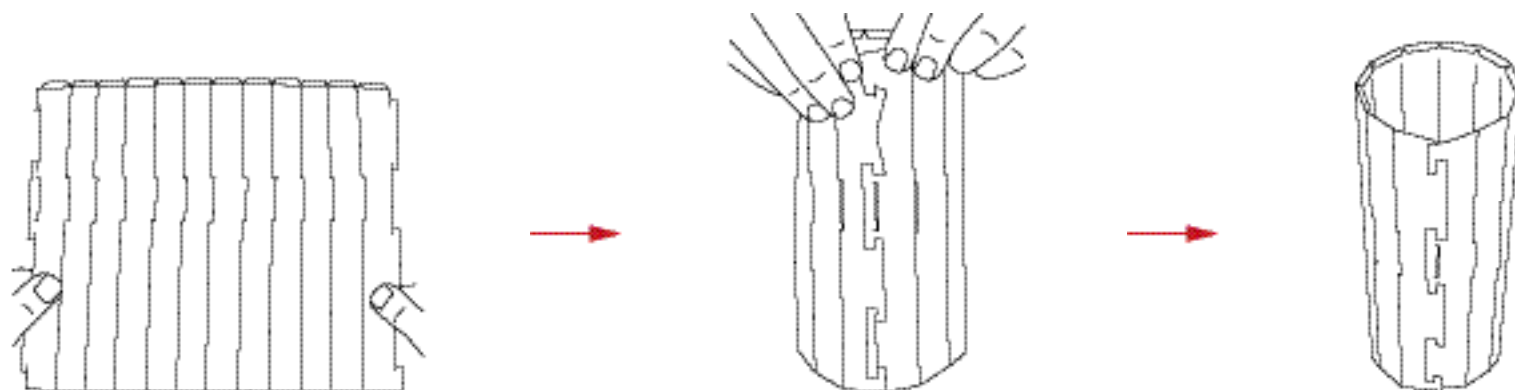

土台部を12面のシリンダーに“作って”ください。縁は上向きに折ってください。

2.

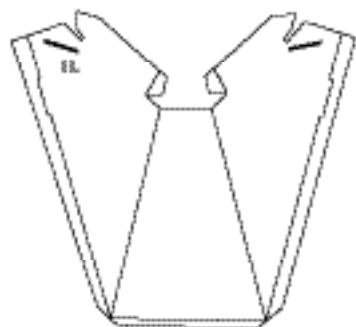

ケースから“11”と書いてあるエレメントを8個出してください。
 二つの切り目の余分の材質は除いてください。

3.

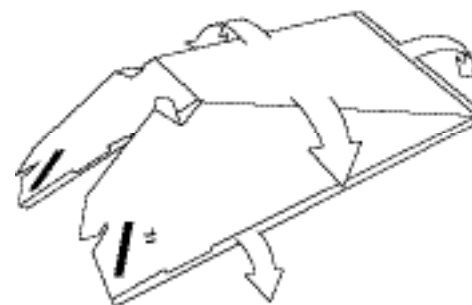

エレメントを圓のように折ってください。
 補強用縁を完全に折り曲げてください。

4.

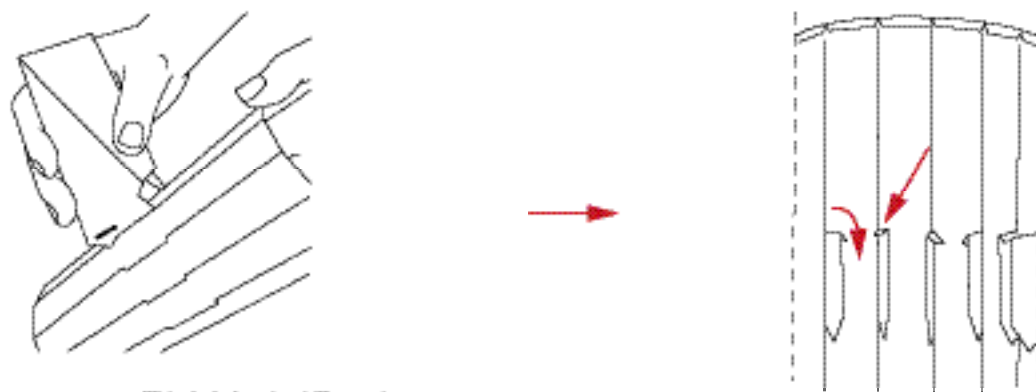

エレメントの真部を土台の切り目に入れ、
 内側の部分をきれいに揃えてください。

5.

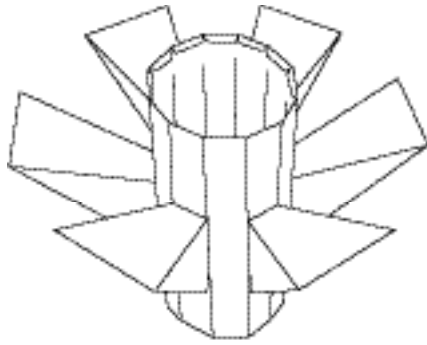

“11”エレメントの付いている土台をさかさまにしてください。“10”エレメント、8個を“11”エレメントと同様に折り曲げてください。

6.

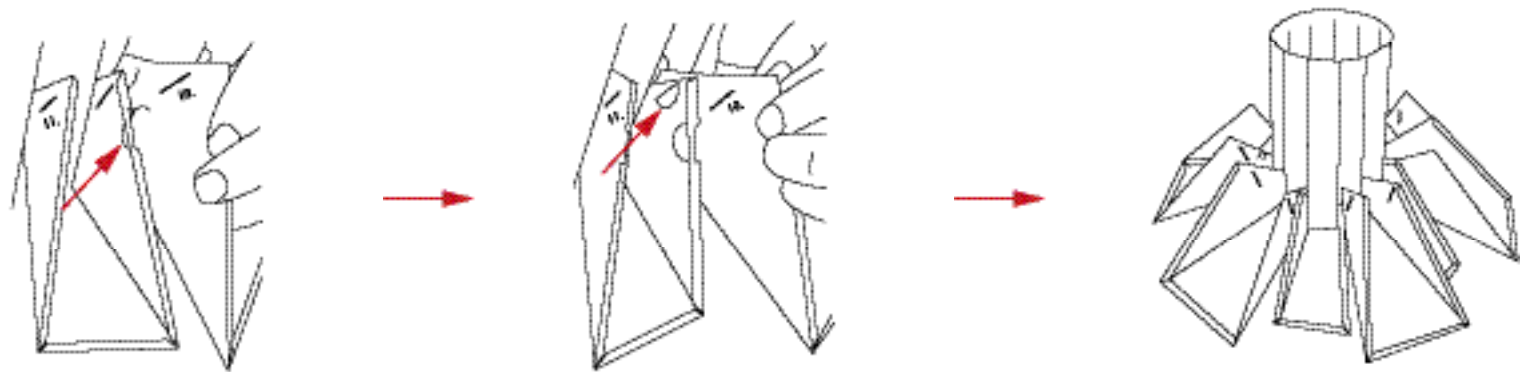

“10”エレメント8個を圓のように“11”エレメント上に付けてください。

7.

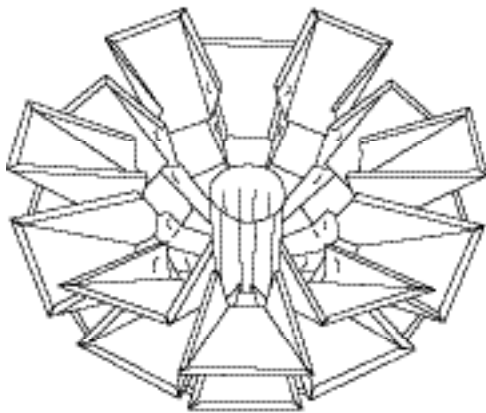

同様に“9”、“8”および“7”エレメント
6個を圓のように付けてください。

8.

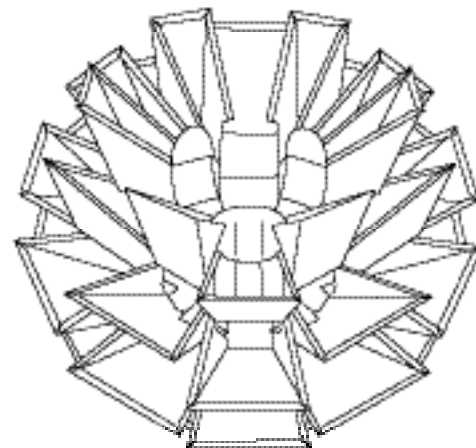

同様に“6”、“5”および“4”エレメント
6個を圓のように付けてください。

9.

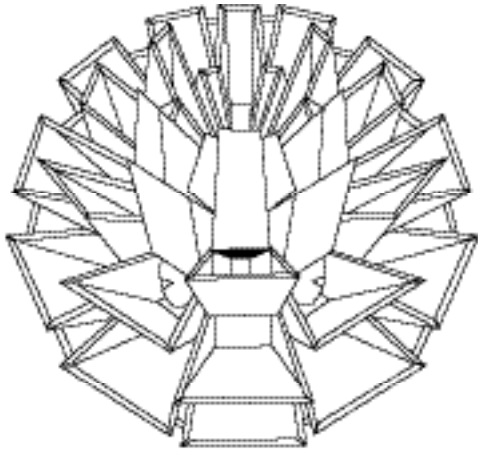

最後に「3」、「2」および「1」エレメント
6個を折り曲げ、付けてください。

10.

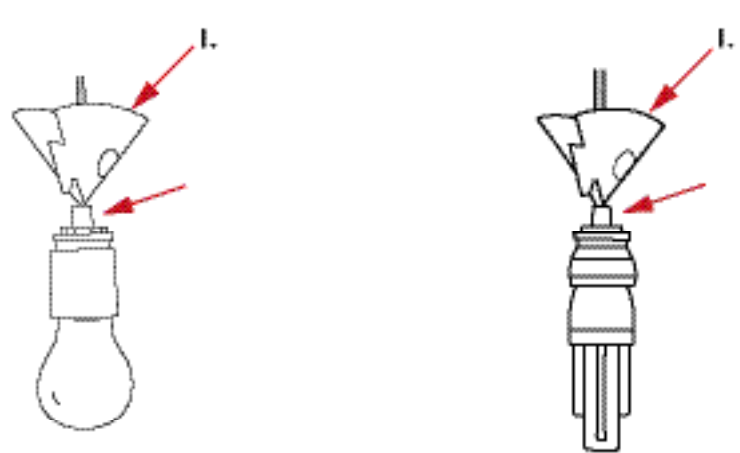

最初の吊り下げエレメントをコードのまわりに尖った先を下にして「作って」ください。
吊り下げエレメントと電球のねじ込み口との間は間隔をとることが**重要!**です。
ですから添付のねじは、図のように必ずコードにとりつけてください。

11.

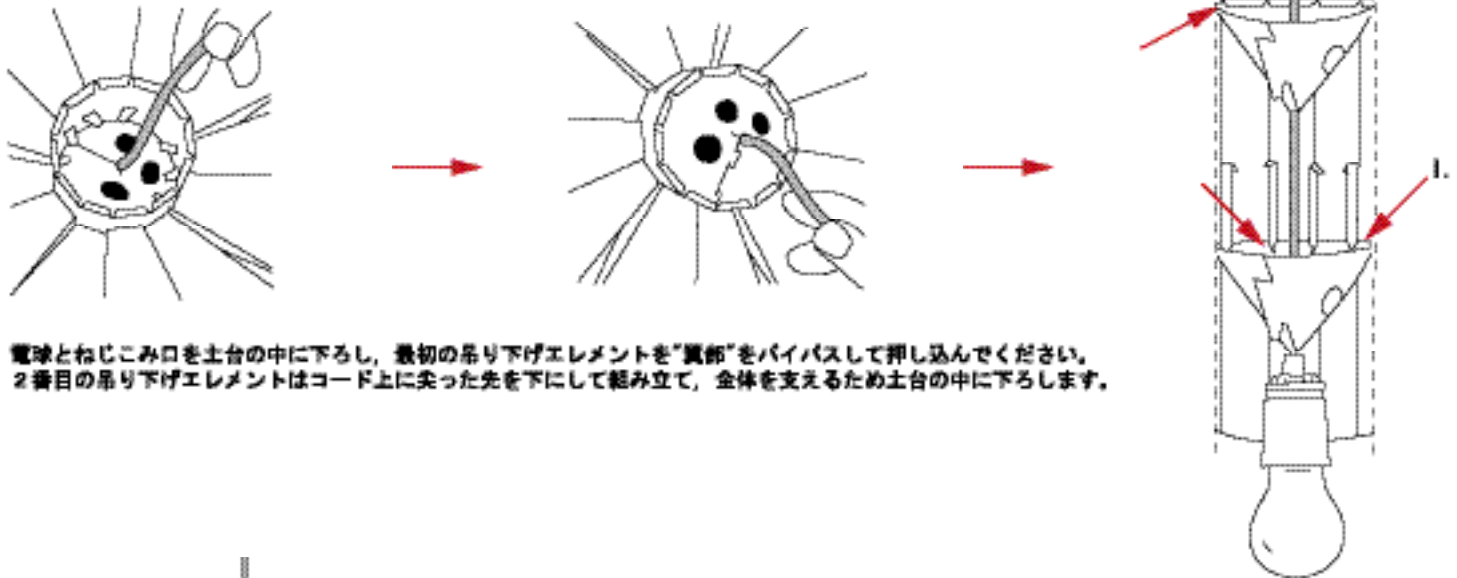

電球とねじ込み口を土台の中に下ろし、最初の吊り下げエレメントを「真部」をバイパスして押し込んでください。
2番目の吊り下げエレメントはコード上に尖った先を下にして組み立て、全体を支えるため土台の中に下ろします。

12.

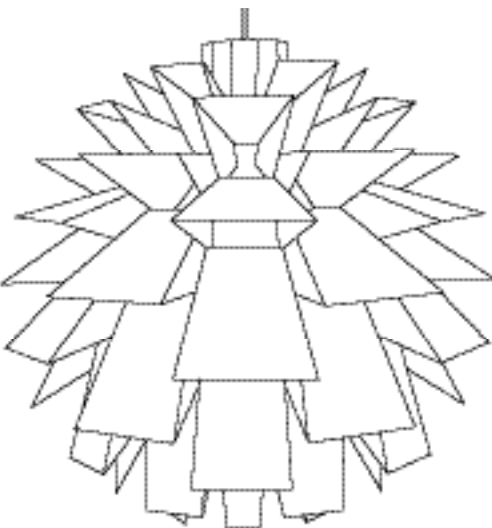

吊り下げるばかりになった完成ランプ

ランプの吊り下げ

ランプはランプの取り付け部を外す必要なく、吊り下げられます。
ランプの底は柔軟ですから、電球のは簡単に交換できます。

最大80ワット

